

**BEFORE THE NATIONAL GREEN TRIBUNAL
PRINCIPAL BENCH AT NEW DELHI**

M.A. No. 18/2026

IN

Execution Application No. 77/2025

IN THE MATTER OF:-

Mohd Saleem

...Applicant

Vs

Central Pollution Control Board & Ors.

...Respondents

Index

Sr. No.	Particulars	Page No.
1.	Affidavit on behalf of CPCB, Respondent No.1, in compliance to Hon'ble NGT Order dated 27.02.2026 in M.A. No. 18 of 2026 in E.A. No. 77 of 2025.	1 - 5
2.	Annexure-I :- A copy of Gazette notification dated 28.10.2016 G.S.R. 1016(E).	6 - 8
3.	Annexure-II :- A copy of CPCB published "Revised Comprehensive Industry Document on Slaughter houses" in October 2017".	9 - 96
4.	Annexure-III :- A copy of CPCB issued directions letter dated 14.01.2022.	97 - 106

Filed by Advocate Vikrant Pachnanda
(On behalf of Central Pollution Control Board)

Place: New Delhi

Dated: - 25.05.2026

BEFORE THE NATIONAL GREEN TRIBUNAL
PRINCIPAL BENCH AT NEW DELHI
M.A. No. 18/2026
IN
Execution Application No. 77/2025

IN THE MATTER OF:

Mohd Saleem

Applicant

Vs

Central Pollution Control Board & Ors.

Respondents

AFFIDAVIT ON BEHALF OF THE CENTRAL POLLUTION CONTROL BOARD RESPONDENT NO.1 IN COMPLIANCE TO THE ORDER DATED 27.02.2026 PASSED BY THIS HON'BLE TRIBUNAL.

MOST RESPECTFULLY SHOWETH:

I, Dinabandhu Gouda, working as Scientist 'F' in Central Pollution Control Board, Parivesh Bhawan, East Arjun Nagar, Delhi, the Respondent No.1, in this matter do hereby solemnly swear and affirm as follows:

1. That in my official capacity as stated above, I am aware of the facts and circumstances of the present case and am competent to swear to the contents of the present affidavit. I state that my knowledge in this regard is based on the official records available with the Central Pollution Control Board (CPCB), New Delhi.
2. That the Hon'ble NGT in the M.A No. 18/2026 of OA No. 77/2025 vide order dated 27.02.2026 gave the following directions:

"...5. Issue notice of the M.A. to the respondents. Applicant is directed to serve the respondents and file affidavit of service at least one week before the next date of hearing."



3. That the Applicant has filed the present Miscellaneous Application seeking to place objections on record against the Action Taken Report dated 05.02.2026 filed by the Uttar Pradesh Pollution Control Board (UPPCB) in compliance of the order dated 18.11.2025 passed by this Hon'ble Tribunal in E.A. No. 77/2025.
4. That in the present Miscellaneous Application, the Applicant has, inter alia, prayed that this Hon'ble Tribunal direct UPPCB and CPCB to issue appropriate environmental regulatory directions to ensure that slaughtering activities of licensed meat shop owners are carried out only at authorised and environmentally compliant slaughterhouses, including those situated at Khurja City, Bulandshahar, Uttar Pradesh.
5. That, at the outset, the Answering Respondent denies all claims, contentions, allegations and averments against it in the OA which are contrary to anything stated or submitted in this reply. Nothing in the OA shall be deemed to have been accepted or admitted by the Answering Respondent for want of a specific save any averment which has been expressly admitted hereinafter.
6. That, CPCB is constituted under Section 3 of The Water (Prevention and control of Pollution) Act, 1974. It performs the functions under the Water (Prevention and control of Pollution) Act 1974 (hereinafter referred as Water Act), the Air (Prevention and control of Pollution) Act, 1981 (hereinafter referred as Air Act) and the Environment (Protection) Act, 1986.



7. That, it is humbly submitted that the State Pollution Control Boards / Pollution Control Committees [for short "SPCBs/PCCs"] have been constituted in States / Union Territories under the Water Act and Air Act, and are empowered to perform the functions and implement the provisions of these Acts in respect of their Territorial Jurisdiction.
8. That, the revised standards for discharge of effluents from slaughter houses were notified on 28.10.2016 under the Environment (Protection) Act 1986 as: *pH: 6.5 to 8.5; SS: 50 mg/l; BOD: 30 mg/L; COD:250 mg/L and Oil and Grease-10 mg/L.(Annexure-I)*
9. That, CPCB published "Revised Comprehensive Industry Document on Slaughter houses" in October 2017". The said document stipulates, best available treatment technologies for wastewater from slaughterhouse, solid waste management and odour management etc.*(Annexure-II)*
10. That, CPCB issued directions dated January 14, 2022 under section 18(1)(b) of the Water Act, 1974 and 18(1)(b) of the Air Act, 1981, to all the SPCBs/PCCs, to install Rendering Plant (dry) along with blood coagulator for processing of animal waste; and to install well designed effluent Treatment Plant for treatment of wastewater so that the treated effluent complies with the standards prescribed under Environment (P) Act, 1986. *(Annexure-III)*.
11. That, as per the list of Grossly Polluting Industries (GPIs) operating in Uttar Pradesh, provided by Uttar Pradesh Pollution Control Board (UPPCB) to CPCB in 2025-26, there are a total of six (06) slaughter-houses operating in Khurja city, Bulandshahar. The details are as follows:

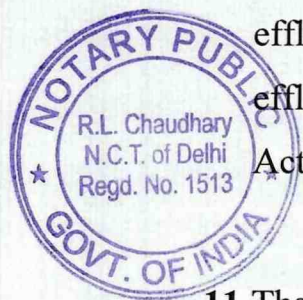

- a. Al Takbeer Frozen Foods Pvt Ltd, Mundakhera Road
Khurja Dstt , Buland Shahar
- b. Barkat Frozen Foods Pvt Ltd, Mundakhera Road, Khurja
, Distt. Bulandshahar (U.P.), Buland Shahar,203131
- c. Agriotek Foods Limited, Mundakhera Road Khurja Distt
,Bulandshahar
- d. Al-Hamd Frozen Foods P. Ltd. (Slaughter House),
Mundakhera Road, Khurja, Distt. Bulandshahr
- e. Leham Export India Pvt.Ltd. Khurja Bulandshahar
- f. Madina Frozen Foods P. Ltd. (Slaughter House),
Mundakhera Road, Khurja, Distt. Bulandshahr

12. That the present Miscellaneous Application pertains to meat shops. Such meat shops are generally regulated and administered by the concerned local municipal authorities/agencies with respect to licensing and inspection, while compliance with food safety requirements is governed by the Food Safety and Standards Authority of India (FSSAI).

13. That, in the light of the above submissions, it is respectfully submitted that the Answering Respondent shall abide by any order(s) and / or direction(s) passed by the Hon'ble Tribunal in the instant case.



(Dinabandhu Gouda)
Scientist 'F'
Central Pollution Control Board
22.05.2026

VERIFICATION:

Verified at Delhi on this 22 MAY 2026 day ~~2026~~ May 2026 that the contents of the above reply affidavit are correct and true based on the records of the case as mentioned in the day-to-day affairs of the CPCB. Nothing has been concealed therefrom or misstated.



DEPONENT



ATTESTED

NOTARY PUBLIC
GOVT. OF INDIA

22 MAY 2026

दीनबन्धु गौड़ा / Dinabandhu Gauda
श्रेणिक 'ब' / Scientist F
राष्ट्रीय वायुमल प्रदूषण नियंत्रण बोर्ड
Central Pollution Control Board
(परिसर, वा. और वायुमल प्रदूषण नियंत्रण, भारत सरकार)
(Site Enforcement, Pollut & Climate Change, Govt. of India)
पतिका भवन, पूर्वी अजमेर मार्ग, दिल्ली-110032
Patvash Bhawan, East Arjun Nagar, Delhi-110032

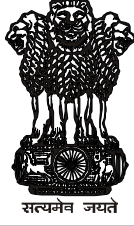

भारत का राजपत्र The Gazette of India

असाधारण

EXTRAORDINARY

भाग II—खण्ड 3—उप-खण्ड (i)

PART II—Section 3—Sub-section (i)

प्राधिकार से प्रकाशित

PUBLISHED BY AUTHORITY

सं. 750]

नई दिल्ली, शुक्रवार, अक्टूबर 28, 2016/कार्तिक 6, 1938

No. 750]

NEW DELHI, FRIDAY, OCTOBER 28, 2016/KARTIKA 6, 1938

पर्यावरण, वन और जलवायु परिवर्तन मंत्रालय

अधिसूचना

नई दिल्ली, 28 अक्टूबर, 2016

सा.का.नि. 1016(अ) .—केन्द्रीय सरकार, की धारा 6 और धारा 25 द्वारा प्रदत्त शक्तियों का प्रयोग करते हुए, पर्यावरण (संरक्षण) नियम, 1986 का और संशोधन करने के लिए निम्नलिखित नियम बनाती है, अर्थात्:-

1. संक्षिप्त नाम और प्रारंभ-

- (1) इन नियमों का संक्षिप्त नाम पर्यावरण (संरक्षण) छठा संशोधन नियम, 2016 है।
- (2) ये राजपत्र में उनके प्रकाशन की तारीख को प्रवृत्त होंगे।

2. पर्यावरण (संरक्षण) अधिनियम, 1986 की अनुसूची 1 में, क्रम संख्या 50 और उससे संबंधित प्रविष्टियों के स्थान पर निम्नलिखित क्रम संख्यांक और प्रविष्टियां रखी जाएंगी, अर्थात्:-

वधशालाओं, मांस प्रसंस्करण यूनिटों और समुद्री खाद्य उद्योग

क्रम सं.	उद्योग	पैरामीटर	मानक
1	2	3	4
"50	क. वधशालाएं या मांस प्रसंस्करण यूनिटें या दोनों*	बहिस्त्राव	पीएच के सिवाय अधिकतम सकेंद्रण मूल्य मिलीग्राम /1 में हैं
		पीएच	6.5 से 8.5
		जैव रासायनिक ऑक्सीजन डिमांड (बीओडी) [3 दिन	30

5059GI/2016

(1)

		27 ⁰ सेल्सियस]	
		रासायनिक ऑक्सीजन डिमांड (सीओडी)	250
		निलंबित पिंड	50
		तेल और ग्रीज	10
	ख. समुद्री खाद्य उद्योग*	जैव रासायनिक ऑक्सीजन डिमांड (बीओडी) [3 दिन 27 ⁰ सेल्सियस]	30
		निलंबित पिंड	50
		तेल और ग्रीज	10

*वधशालाएं या मांस प्रसंस्करण यूनिटें या दोनों और समुद्री खाद्य उद्योग के बायलर घर से उत्सर्जन मानक पर्यावरण (संरक्षण) अधिनियम, 1986 के अधीन समय समय पर यथा संशोधित अधिसूचना सं. सा.का.नि. 742(अ), तारीख 30.08.1990 द्वारा विहित किया गया था।

टिप्पणः(i) स्थानीय निकायों/नगर पालिकाओं में प्रचालित की जा रही वधशालाओं के लिए जहां बहिःस्राव पूर्ण मल व्ययन उपचार संयंत्र की ओर जाने वाली नगरपालिका मल नालियों में निस्सारित किया जाता है वहां बीओडी 100मि.ग्रा./1 तक शिथिल किया जा सकता है।

(ii) सभी वधशालाएं और मांस प्रसंस्करण यूनिटें एसपीसीबी और पीसीसी द्वारा अनुमोदित उपयुक्त प्रौद्योगिकी के माध्यम से ठोस अपशिष्ट {टाइप 1 (वनस्पति जन्य पदार्थ जैसे प्रथम अमाशय, अमाशय, आंत्र में मौजूद पदार्थ, गोबर, कृषि अवशेष) और टाइप 2 जीव जंतु पदार्थ जैसे अखाद्य अपशिष्ट, उत्तक, मांस परिकर्तन, अपशिष्ट और बेकार मांस, अस्थियां आदि} का सुरक्षित और उचित निपटान सुनिश्चित करेंगी।”।

[फा. सं. क्यू-15017/21/2015-सीपीडब्ल्यू]

डा. राशिद हसन, सलाहकार

MINISTRY OF ENVIRONMENT, FOREST AND CLIMATE CHANGE

NOTIFICATION

New Delhi, the 28th October, 2016

G.S.R. 1016(E).— In exercise of the powers conferred by sections 6 and 25 of the Environment (Protection) Act, 1986 (29 of 1986), the Central Government hereby makes the following rules further to amend the Environment (Protection) Rules, 1986, namely:-

1. Short title and Commencement.-

- (1) These rules may be called the Environment (Protection) Sixth Amendment Rules, 2016.
- (2) They shall come into force on the date of their publication in the Official Gazette.

2. In the Environment (Protection) Rules, 1986, in Schedule-I, for serial number 50 and the entries relating thereto, the following serial number and entries shall be substituted, namely:-

**STANDARDS FOR DISCHARGE OF EFFLUENTS FROM SLAUGHTERHOUSES, MEAT PROCESSING
UNITS AND SEA FOOD INDUSTRY**

S.No.	Industry	Parameter	Standard
1	2	3	4
“50	A. Slaughterhouses or Meat Processing Units or Both*	Effluents	Maximum Concentration values are in mg/l except for pH
		pH	6.5 to 8.5
		Bio-chemical Oxygen Demand (BOD) [3 days at 27°C]	30
		Chemical Oxygen Demand (COD)	250
		Suspended Solids	50
		Oil and Grease	10
	B.Sea Food Industry*	Bio-chemical Oxygen Demand (BOD) [3 days at 27°C]	30
		Suspended Solids	50
		Oil and Grease	10

*The emission standards from Boiler House of Slaughterhouses or Meat Processing Units or both and Sea Food Industry shall conform to the standards prescribed vide notification No. G.S.R. 742 (E), dated 30.08.1990 as amended from time to time under the Environment (Protection) Act, 1986.

Note:

- (i) For Slaughterhouses operating in local bodies/ municipalities, where the treated effluent is discharged into municipal sewers leading to full-fledged Sewage Treatment Plant, the BOD may be relaxed to 100mg/l.
- (ii) All Slaughterhouses/ meat processing units shall ensure safe and proper disposal of solid waste {Type I (Vegetable matter such as rumen, stomach and intestinal contents, dung, agriculture residues etc) and Type II (Animal matter such as inedible offal, tissues, meat trimmings, waste and condemned meat, bones etc.)} through suitable technology approved by SPCBs/PCCs. ”.

[F.No. Q-15017/21/2015-CPW]

Dr. RASHID HASAN, Adviser

Note- The principal rules were published in the Gazette of India, Extraordinary, Part II, Section 3, Sub-section (i), vide number S.O. 844 (E), dated the 19th November, 1986 and subsequently amended vide the following notifications, namely:—

S.O. 433 (E), dated the 18th April 1987; G.S.R. 176(E), dated the 2nd April, 1996; G.S.R. 97 (E), dated the 18th February, 2009; G.S.R. 149 (E), dated the 4th March, 2009; G.S.R. 543(E), dated the 22nd July, 2009; G.S.R. 739 (E), dated the 9th September, 2010; G.S.R. 809(E), dated, the 4th October, 2010, G.S.R. 215 (E), dated the 15th March, 2011; G.S.R. 221(E), dated the 18th March, 2011; G.S.R. 354 (E), dated the 2nd May, 2011; G.S.R. 424 (E), dated the 1st June, 2011; G.S.R. 446 (E), dated the 13th June, 2011; G.S.R. 152 (E), dated the 16th March, 2012; G.S.R. 266(E), dated the 30th March, 2012; and G.S.R. 277 (E), dated the 31st March, 2012; and G.S.R. 820(E), dated the 9th November, 2012; G.S.R. 176 (E), dated the 18th March, 2013; G.S.R. 535(E), dated the 7th August, 2013; G.S.R. 771(E), dated the 11th December, 2013; G.S.R. 2(E), dated the 2nd January, 2014; G.S.R. 229 (E), dated the 28th March, 2014; G.S.R. 232(E), dated the 31st March, 2014; G.S.R. 325(E), dated the 07th May, 2014, G.S.R. 612, (E), dated the 25th August 2014; G.S.R. 789(E), dated the 11th November 2014; S.O. 3305(E), dated the 7th December, 2015; S.O.4(E), dated 1st January 2016; G.S.R. 35(E), dated 14th January 2016, G.S.R. 281 (E), dated 7th March, 2016; G.S.R. 496(E), dated 09th May, 2016 and lastly amended vide notification G.S.R.497(E), dated 10th May, 2016.



Central Pollution Control Board
PARIVESH BHAWAN
East Arjun Nagar, Delhi - 110 032

No. IPC-IV/Project-SH/2017-18/

Oct. 23, 2017

OFFICE MEMORANDUM

A Document on ' Characterization, Waste Management Practices & Best Available Pollution Control Technologies in Slaughter Houses' has been prepared recently by CPCB in consultation with Central Leather Research Institute , Chennai. The same is attached herewith for information /reference of all concerned.

[N.K. Gupta]
Divisional Head - IPC-IV

No. IPC-IV/Project-SH/2017-18/

**REVISED COMPREHENSIVE INDUSTRY DOCUMENT
ON
SLAUGHTER HOUSES**



**CENTRAL POLLUTION CONTROL BOARD, DELHI
(Ministry of Environment, Forest and Climate Change,
Government of India)
October 2017**

TABLE OF CONTENTS

Chapter I

1.0 INTRODUCTION	1
1.1 LIVESTOCK POPULATION	1
1.2 MEAT PRODUCTION IN INDIA	2
1.3 REVIEW OF EFFLUENT STANDARDS FOR SLAUGHTER HOUSES	4
1.4 SCOPE OF THE WORK	4

Chapter II

2.0 INVENTORY STUDIES	6
2.1 STATUS OF SLAUGHTER HOUSES IN INDIA	6
2.2 CLASSIFICATION OF SLAUGHTER HOUSES	8
2.2.1 Type of slaughter house based on animal slaughtered	8
2.2.2 Type of slaughter house based on processes	8
2.2.3 Type of slaughter house based on capacity of Slaughter house	9

Chapter III

3.0 WASTE MANAGEMENT IN SLAUGHTER HOUSES	10
3.1 TYPICAL PROCESS FLOW DIAGRAM OF SLAUGHTER HOUSE	10
3.1.1 Animal holding	10
3.1.2 Lairage	10
3.1.3 Abattoir / Slaughterhouse	10
3.1.4 Chilling room	11
3.1.5 Processing	11
3.1.6 Freezing	11
3.1.7 Cold storage	11
3.1.8 Rendering	11
3.2 EFFLUENT GENERATION FROM SLAUGHTER HOUSE	12
3.3 SOLID WASTE GENERATION FROM SLAUGHTER HOUSE	13
3.4 ENVIRONMENTAL IMPACTS OF WASTE DISPOSAL	14
3.4.1 Water	14
3.4.2 Air	14
3.4.3 Solid waste	14
3.4.4 Odour	15

3.5 ENVIRONMENTAL GUIDELINES AND STANDARDS FOLLOWED IN OTHER COUNTRIES	15
3.6 BEST AVAILABLE TECHNOLOGY (BAT)	16
3.6.1 Primary treatments	16
3.6.1.1. Screening	16
3.6.1.2 Dissolved Air Floatation (DAF)	17
3.6.1.3. Oil & Grease Trap	19
3.6.1.4 Primary Settling Tank	20
3.6.1.5. Tube settler	21
3.6.1.6. Electrocoagulation	21
3.6.1.7. Clariflocculator	22
3.6.2 Secondary Treatments	22
3.6.2.1. Upflow Anaerobic Sludge Blanket (UASB)	22
3.6.2.2. Trickling Filter	23
3.6.2.3. Rotating Biological Contactor	24
3.6.2.4. Packed bed reactors	25
3.6.2.5 Anaerobic digester	25
3.6.2.6. Anaerobic lagoon	26
3.6.2.7 Activated Sludge Process (ASP)	27
3.6.2.8. Waste Stabilization Ponds (WSP)	28
3.6.3 Tertiary treatment	30
3.6.3.1 Pressure Sand Filter	30
3.6.3.2 Activated Carbon Adsorption (AC)	31
3.6.3.3 Ultra filtration (UF)	32
3.6.3.4 Disinfection/ Ozonation	33
3.7 BEST PRACTICABLE TECHNOLOGY (BPT)	36
3.7.1. Primary Treatment	36
3.7.1.1 Screening	36
3.7.1.2 Dissolved Air flotation (DAF)	36
3.7.1.3 Oil & Grease Trap	37
3.7.1.4 Primary Settling Tank & Clari-flocculator	38
3.7.2 Secondary Biological Treatments	38
3.7.2.1 Anaerobic digester	38
3.7.2.2 Upflow Anaerobic Sludge Blanket (UASB)	39
3.7.2.3 Packed Bed Reactor	39
3.7.2.4 Activated Sludge Process (ASP)	39
3.7.3 Tertiary Treatment	40
3.7.3.1 Pressure Sand Filter (PSF)	40
3.8 TREATMENT ADOPTED IN SLAUGHTER HOUSES BASED ON THE SURVEY	41
3.9 COMPLIANCE WITH STANDARDS	44

Chapter IV

4.0 IN-DEPTH STUDIES IN SLAUGHTER HOUSES	45
4.1 BASIC INFORMATION ON UNITS SELECTED FOR THE IN-DEPTH STUDIES	45
4.2 TREATMENT COST ANALYSIS BASED ON THE IN-DEPTH STUDIES	49

Chapter V

5.0 REVIEW OF EFFLUENT STANDARDS	52
5.1 BEST PRACTICABLE TECHNOLOGIES (BPT) FOR CONTROL OF WATER POLLUTION IN SLAUGHTER HOUSES	52
5.1.1 Large scale slaughter houses	52
5.1.2 Medium and small scale slaughter houses	52
5.2 REVISED EFFLUENT STANDARDS	54
5.2.1 Pre-revision standards for slaughter houses	54
5.2.2 Revised standards for slaughter houses	55
5.3 SCHEDULES FOR MONITORING THE POLLUTION LEVEL	56
5.4 METHODS FOR TREATMENT AND DISPOSAL OF SOLID WASTES FROM SLAUGHTER HOUSE WASTES	57
5.4.1 Classification of solid waste	57
5.4.2 Solid waste management	57
5.4.2.1 Composting	57
5.4.2.2 Bio-methanation	58
5.4.2.3 Rendering	61
5.4.2.4 Incineration	63
5.4.3 CONCLUSIONS AND RECOMMENDATIONS	64

ANNEXURES

Annexure-I Details of State wise Slaughter Houses in India	
Annexure-II Slaughter houses-cum-meat processing plants and standalone slaughter houses registered with APEDA for export of meat from India	
Annexure-III Questioner for collection of Data from Slaughter Houses	

LIST OF TABLES

Table 1 Water consumption details
 Table 2 Sources of effluent generation
 Table 3 Typical Characteristics of Slaughter house wastewater
 Table 4 Sources of solid wastes
 Table 5 Typical Characteristics of Solid wastes
 Table 6 Standards adopted for Slaughter House effluent in other countries
 Table 7 Details of coarse screens
 Table 8A and 8B Consolidated statistics of slaughter houses based on in-depth Studies
 Table 9 Performance of ETPs of slaughter houses based on in-depth Studies
 Table 10 Treatment Cost Analysis for anaerobic followed by aerobic treatment system
 Table 11 Treatment Cost Analysis for Aerobic treatment system
 Table 12 Pre-revision standards for Slaughter house notified on 21.2.1991 under Environment (Protection) Rules 1986
 Table 13 Revised standards for slaughter house notified on 28.10.2016 under the Environment (Protection) Rules, 1986
 Table 14 Classification of solid wastes
 Table 15 Economics of a biogas plant
 Table 16 Economics of high rate biomethanation plant
 Table 17 Economics of dry rendering plant
 Table 18 Methods for processing, utilization and disposal of solid wastes from slaughter house

LIST OF FIGURES

Figure 1 Livestock population 1951-2007-All India Census estimates
 Figure 2 Livestock population census 2010 - Asia and India
 Figure 3 International production of Goat meat (Top 5 Countries in 2011)
 Figure 4 International production of sheep meat (Top 5 Countries in 2011)
 Figure 5 International production of Buffalo meat (Top 5 Countries in 2011)
 Figure 6 Distribution of slaughter houses in India (map).
 Figure 7 Classification of slaughter house based on type of animal slaughtered
 Figure 8 Classification of slaughter house based on type of slaughtering process
 Figure 9 Typical process flow diagram of slaughter house process
 Figure 10A Treatment scheme - I
 Figure 10B Treatment scheme - II
 Figure 10C Treatment scheme - III
 Figure 10D Treatment scheme - IV
 Figure 10E Treatment scheme - V
 Figure 10F Treatment scheme - VI
 Figure 11 Schematic flow diagram of BPT option for effluent treatment in large slaughter houses
 Figure 12 Schematic flow diagram of BPT option for effluent treatment in medium & small slaughter houses
 Figure 13 Schematic diagram of Conventional Biogas Plant
 Figure 14 Schematic diagram of a typically high rate biomethanation plant
 Figure 15 Schematic diagram of the integrated wet rendering plant
 Figure 16 Schematic diagram of typical dry rendering plant

1.0 INTRODUCTION

1.1 LIVESTOCK POPULATION

According to Food and Agriculture Organization Statistics (FAOSTAT), the world livestock population is about 195 million buffaloes, 1428 million cattles, 924 million goat and 1093 million sheep. Asia is one of the major contributor continents as it contributes 97% of buffalo population, 33% of cattle population, 59% of goat population and 43% of sheep population of the world, and India ranks top among countries in the world in terms of number of cattle, buffaloes and goat. According to the livestock census 2011, India has 113 million buffaloes, 211 million cattles, 157 millions goat and 74.5 million sheep populations, which is 58%, 15%, 17% and 7% of their world population, respectively. Profile of livestock population (cattle & buffalo, and sheep & goat) as per all India Census Estimates during 1951 to 2007 are shown in Figure 1.

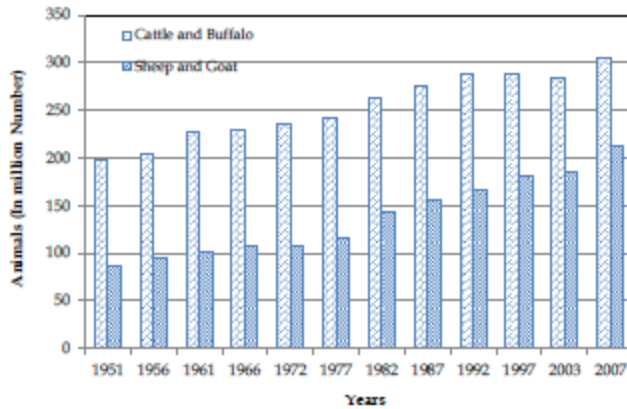

Figure 1 Livestock population 1951-2007-All India Census estimates

Source: Livestock Census, Directorate of Economics & Statistics, and Animal Husbandry Statistics Division, Department of Animal Husbandry, Dairying & Fisheries, Ministry of Agriculture

In India, livestock production during the period from 2001 to 2011, cattle population increased by 11.2%; buffalo by 18.6%; sheep and goat by 23.9% and 26.8% respectively. Livestock population of Asia and India in the world livestock population as per 2010 census is given Figure2.

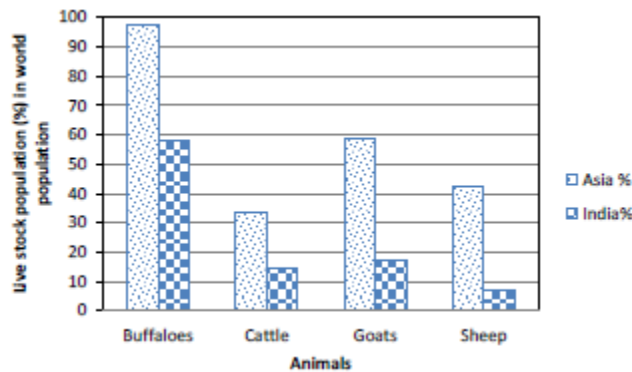

Figure 2 Livestock population census 2010 - Asia and India

Source: FAO Livestock Census 2011

Top five countries in goat, sheep and buffalo meat production in the world are shown in Figures 3, 4 & 5.

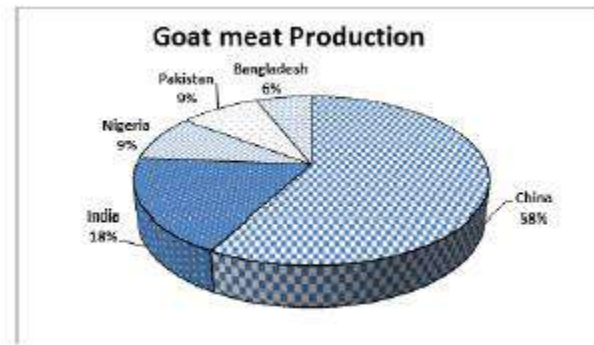

Figure 3 International production of Goat meat (Top 5 Countries in 2011)

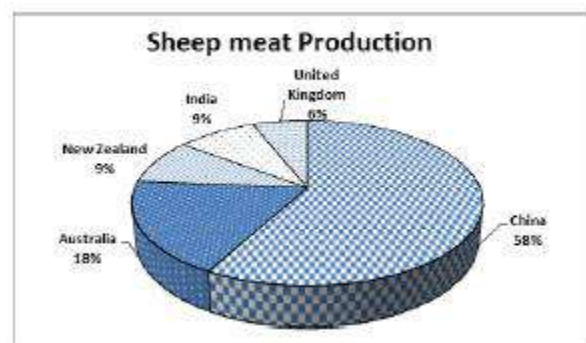

Figure 4 International production of sheep meat (Top 5 Countries in 2011)

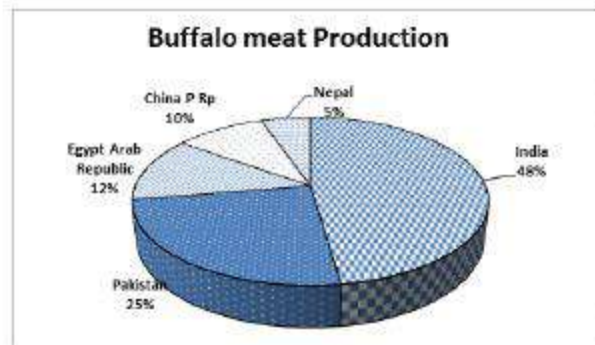

Figure 5 International production of Buffalo meat (Top 5 Countries in 2011)

1.2 MEAT PRODUCTION IN INDIA

India is second largest exporter of meat product. According to FAOSTAT (2010), India is exporting about 14,49,100 tonnes of meat all over the world, which amounts to US\$ 1511 million. **The annual production of buffalo meat alone in India is more than 1.5 million tonnes and accounts for about 30% of total meat production. The contribution in the meat production by cattle, sheep, goats and poultry is 30%, 5%, 10%, and 11.5% respectively.**

Most of the small animals slaughtered (goat & sheep) are sold in the local market. Hence, the export of sheep and goat meat in terms of quantity is very small. Exports of value added meat products are also insignificant. Export is primarily restricted to countries in the Middle East, with large ethnic Indian population who prefer it. According to Agriculture and Processed

Food Products Export Development Authority (APEDA), the export of buffalo meat was 11,07,506.24 tonnes (Rs. 17,41,289.27 Lakhs) and sheep/goat meat was 16,046,91 tonnes (Rs. 42,565.86 Lakhs) in 2012-13. Meat exports have been growing at a rate of 25-30% per annum in terms of quantity, which is largely driven by buffalo, sheep and goat meat.

The increase in per capita income and urbanization are fuelling the demand for meat and meat products. While the population is expected to double in Asia and Africa by the year 2020, the demand for meat and meat products is expected to triple. Per-capita meat consumption in India is relatively low at less than 5 Kg/year as compared to other developing countries such as Pakistan (13.7 Kg/year), China (38.6 Kg/year) and Brazil (58.6 Kg/year). Based on the minimum requirement of 20 g animal protein per capita per day sourced from milk (10 g), meat (4 g), fish (4 g), and eggs (2 g), the estimated demand for meat is 7.7 Million Metric Tonnes (MMT) as against the present production of 4.6 MMT.

India's exports are revised to 1.75 million tonnes higher to 1.5 million tonnes making it the world leader. Expanding demand from importers, primarily in Southeast Asia, the Middle East and Africa have bolstered an increase in the number of export orientated slaughterhouses.

In India, domestic market is also growing with increase in number of fast food outlets. But, the meat sector is still one of the poorly organized sectors. Though the consumption of meat is on increase, the quality aspects have not been adequately addressed so far.

With enactment of Food Safety and Standards Act 2006, all the food items produced in the country will have to meet the standard stipulated. Meat is probably one item, which had not been paid adequate attention in this regard. Municipal slaughterhouses are under the control of corporation / municipal authorities and no effort has been made to make meat production as an important economic activity. Lack of awareness, poor private participation and environmental problems are some of the constraints in providing hygienic meat and meat products.

The effluents and solid waste generated from slaughterhouse are disposed without proper treatment. Solid waste is disposed along with Municipal Solid waste in open dumping in most of the cities and towns. Few slaughterhouses operated by municipal /corporation have established treatment plants and some have also engaged services of private companies for operation and maintenance of mechanized slaughter houses.

1.3 REVIEW OF EFFLUENT STANDARDS FOR SLAUGHTERHOUSES

MINAS were prescribed by CPCB in 1990 and there have been considerable changes in the effluent treatment technologies and hence there was a need for review and revision of effluent standards for slaughter houses in the country. For this purpose, CPCB prepared the following scope of work and engaged the services of CSIR-CLRI for review of effluent standards for slaughter houses.

1.4 SCOPE OF THE WORK

Task 1: CLRI will collect basic information from industries / concerned organizations through questionnaire survey and literature survey, and prepare database of the slaughterhouses operating in the country covering the following:

- a. Status of slaughter houses in India including number of slaughter houses, animal slaughtered / production and other relevant statistical information such as size, year of establishment, location, water consumption, effluent generation, it's treatment and disposal, compliance with standards, waste management aspects, treatment cost (Annual Burden / Annual Turnover) etc.
- b. Classification of slaughter houses based on type of animals slaughtered / processes / capacity; and
- c. Processes, pollution control technologies (Best Practicable Technologies (BPT), Best Availability Technology (BAT)), environmental guidelines and standards followed in other countries.

Task 2: Based on review of information from Task 1, CLRI shall identify upto 12 representative slaughterhouses and carry out in-depth studies in consultation with CPCB. While selecting the representative slaughterhouses for in-depth studies, different categories based on size, process etc. will be taken into consideration. The representatives of large, medium and small industries based on different processes / type of animal and capacity will be included for in-depth studies. Also regional spread will be taken into consideration.

CLRI will inform the in-depth study/monitoring programme to CPCB in advance so that representative of the CPCB, could be present during the in-depth study / monitoring programme.

Task 3: In-depth studies in upto 12 identified / selected slaughter houses covering the following:

- a. Description of production process with flow diagram
- b. Raw materials / animals, products etc.
- c. Genesis of pollution and identification of pollutants / parameters in effluents and solid wastes, their quantities and sources of generation; monitoring and analysis of pollution in different waste streams and solid waste;
- d. Preparation of overall water balance unit operation-wise including water consumption, wastewater generated (quantity / quality), treatment and disposal;

- e. Analysis of individual process effluent streams, combined effluent and performance evaluation of effluent treatment facility;
- f. Measures taken to reduce water consumption including recycling / reuse etc.;
- g. Measures taken for water pollution reduction and effluent treatment facilities including recycling / reuse;
- h. Measures taken for processing / disposal of solid wastes and byproducts;
- i. Cost of treatment including annual burden (annualized cost of capital investment on water pollution control measures + overall cost of water pollution control measures), annual turnover of slaughter houses studies and
- j. Disposal of treated effluents and likely impacts if any.

Task 4: CLRI will identify Best Practicable Technologies (BPT) for water pollution control and best technologies currently available for different categories of slaughterhouses in India and abroad.

Task 5: Review / development of effluent standards and guidelines:

- a. CLRI will review the existing effluent standards for slaughter houses as notified under the Environment (Protection) Rule, 1986 and recommend if they are to be amended;
- b. CLRI will review the existing effluent standards / guidelines / norms being followed in other countries;
- c. CLRI will suggest revised effluent standards / norms and guidelines in line with the principles followed by CPCB (Ref: CPCB publication No. PROBES/67/1996-97) for setting of standards;
- d. CLRI will suggest effluent treatment process / technologies and norms / guidelines for disposal of the effluent; and
- e. CLRI will suggest methods for treatment / processing of solid wastes and norms / guidelines for proper disposal of solids wastes.
- f. CLRI will suggest a schedule for monitoring the pollution level in the waste streams indicating frequency of sampling, pollutants to be analyzed, parameters to be monitored, sampling point etc. The standards will be reviewed / developed considering treatment processes / technologies, pollution control cost, recipient environment etc. The standards are desired in terms of concentration of various parameters and quality of effluent. Rationale of suggested standards needs to be described elaborately.

Task 6: CLRI will prepare a study report in the form of a "Comprehensive Industry Document" for slaughterhouse sector including various aspects given in the above tasks as per approved format of CPCB.

Task 7: CLRI will make presentations up to 4 times at CPCB, Delhi during the study and after submission of draft report / including presentations before the Peer and Core Expert Committee of CPCB for finalization of the standards.

2.0 INVENTORY STUDIES

All municipalities do establish slaughter houses, and appoint municipal engineer, health inspector or veterinary doctor for operation and maintenance of slaughter houses. All states are having municipal administration department which oversee the administrative activities related to slaughter houses. Some of the slaughter houses in India have been upgraded or modernized under up-gradation scheme of states/ central government. CLRI prepared questionnaire for each state separately and circulated the questionnaire to all state governments to collect current the status of slaughter houses in the states. Based on the data collected through questionnaire survey and other secondary data, the status of slaughterhouses have been compiled and same has been presented in this chapter.

2.1 STATUS OF SLAUGHTER HOUSES IN INDIA

India has more than 1176 slaughterhouses and 75 modern abattoirs as per APEDA. State wise registered slaughter house in India is given in [Annexure I](#) and presented in [Figure 6](#). List of slaughter houses and meat processing units registered with APEDA is given in [Annexure II](#).

As most of slaughter houses are operated and managed by municipalities, investment for improvement of infrastructure for slaughter houses is difficult. Slaughter houses in rural areas are under the control of local bodies like Panchayats. The slaughterhouses maintained by them get least priority as they have limited resources for this activity and hence no standard practices are followed. Production of meat from these slaughter houses is consumed by domestic retail market cannot be recognized as meat from organized sector.



Figure 6 Distribution of slaughter houses in India (Map).

Schemes to improve slaughterhouses formulated by the Central and State government in the past have been effective in improving the basic infrastructure like building / lighting / water supply / drainage arrangement etc. but some of the slaughter houses which required relocation under the scheme have not been effective mainly since the trader resisted the centralized process of slaughter house. In the existing system, small and medium traders bring their own animals for slaughter and they take back the meat and all by-products with them. While in the modern slaughter houses, it will be difficult for them to get all the by-products of their animals, distance to be travelled may be longer, will pay increased slaughtering fee, there will be no control over method of slaughtering like Halal and Jatka etc., are the concerns of the local meat traders. The number of animal brought by each trader varies from 1-15. Therefore, centralized slaughtering became difficult and inconvenient for small traders. Many slaughter houses which have been upgraded are not used properly to its full capacity or not operational. The Ministry of Food Processing is having a scheme to support large modern slaughterhouses for supply of meat to domestic and export markets. Therefore, all stakeholders should be involved at the planning stage itself, so that the above issues are given due consideration.

To make this sector dynamic, targeting large slaughterhouses will not suffice. Addition of value at the local level will be more important, as it will limit and reduce transport of animals, contain environmental pollution to local levels, and help animal owners to earn more income by providing them direct access to local market. It is important to introduce private participation. The slaughterhouses at industrial scale have been successful mainly in the private sector, and very few government slaughter houses.

Municipal slaughter houses have not been self-sustaining, as the service charges collected by local bodies do not meet even the running expenses and maintenance of units. Small slaughterhouses have not been managed on commercial lines, except in few cases. Slaughter houses are being leased, where hygienic meat processing procedure and environmental related issues are not given adequate importance by lease holders.

Slaughter houses in the country are mostly service oriented units for serving the needs of local people. Slaughter houses, besides catering to the needs of consumers, serve as source of raw materials for a wide range of industries such as tanneries, bone mills, glue manufacturing and livestock animal feed processing units. A large number of slaughter houses are very old and operate with inadequate basic amenities such as lairage, proper flooring and water supply, drainage arrangement and collection and disposal of solid waste.

2.2 CLASSIFICATION OF SLAUGHTER HOUSES

At present there are no official norms for classification of slaughter houses. However, classification were done depending upon the type of animal slaughtered, type of processes for slaughtering of animal and capacity of the slaughter house where animals are slaughtered.

2.2.1 Type of slaughter house based on animal slaughtered

Classification of slaughter house can be done based on type of animal slaughtered:

1. Large animal slaughter house i.e. Cattle and buffalo
2. Small animal slaughter house i.e. Goat and sheep.

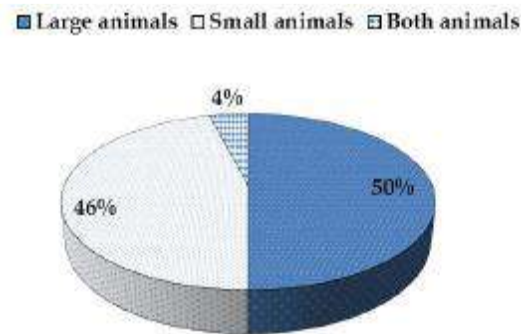

Figure 7 Classification of slaughter house based on type of animal slaughtered

From the data collected from various states, slaughtering of only small and only large animals in India are 46% and 50% respectively, whereas 4% of slaughter house slaughters both small and large animals together.

2.2.2 Type of slaughter house based on processes

Classification of slaughter house based on type of process adopted for slaughtering:

1. Manual slaughtering
2. Semi mechanized
3. Mechanized

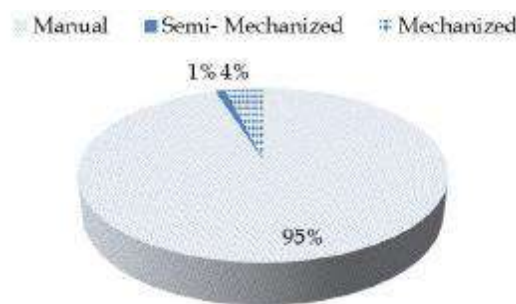

Figure 8 Classification of slaughter house based on type of slaughtering process

Most of municipal slaughter houses operated by municipalities / corporations are normally manual, few are or semi-mechanized, very few like in New Delhi, Mumbai and Hyderabad which are fully mechanised. Export oriented private slaughter houses are fully mechanized for slaughtering of animals and processing of meat.

2.2.3 Type of slaughter house based on capacity of slaughter house

Earlier the slaughter houses were categorized based on tonnes of live weight of animals killed per day (TLWK/day), but it is very difficult to quantify the live weight of animals killed per day in municipal/corporation slaughter houses. Also linking number of animals with total live weight is also difficult as there is considerable variation in live weight of animals killed per day for both small and large animals in towns and cities. It is better, easy and convenient to count number of small and large animals being slaughtered in slaughter houses. Many of slaughter houses operated in cities and towns under control of municipal administration have reported that the animals killed on festive days are about 2 to 3 times the daily average. Hence, previous categorization based on live weight basis, needs to be re-categorized based on number of animals slaughtered as below:

Based on the number of animals slaughtered, the slaughter houses are classified into small, medium and large. The basis of classification is given below:

- Large: More than 200 large animal i.e. bovines per day, or more than 1000 small animal i.e. goat and sheep per day (any day in a week).
- Medium: 50 to 200 large animal i.e. bovines per day, or 300 to 1000 small animal i.e. goat and sheep per day (any day in a week)
- Small: Less than 50 large animal i.e. bovines per day, or less than 300 small animal i.e. goat and sheep per day (any day in a week)

3.0 WASTE MANAGEMENT IN SLAUGHTER HOUSES

3.1 TYPICAL PROCESS FLOW DIAGRAM OF SLAUGHTER HOUSE

Typical process flow diagram of slaughtering process in India is given in [Figure 9](#).

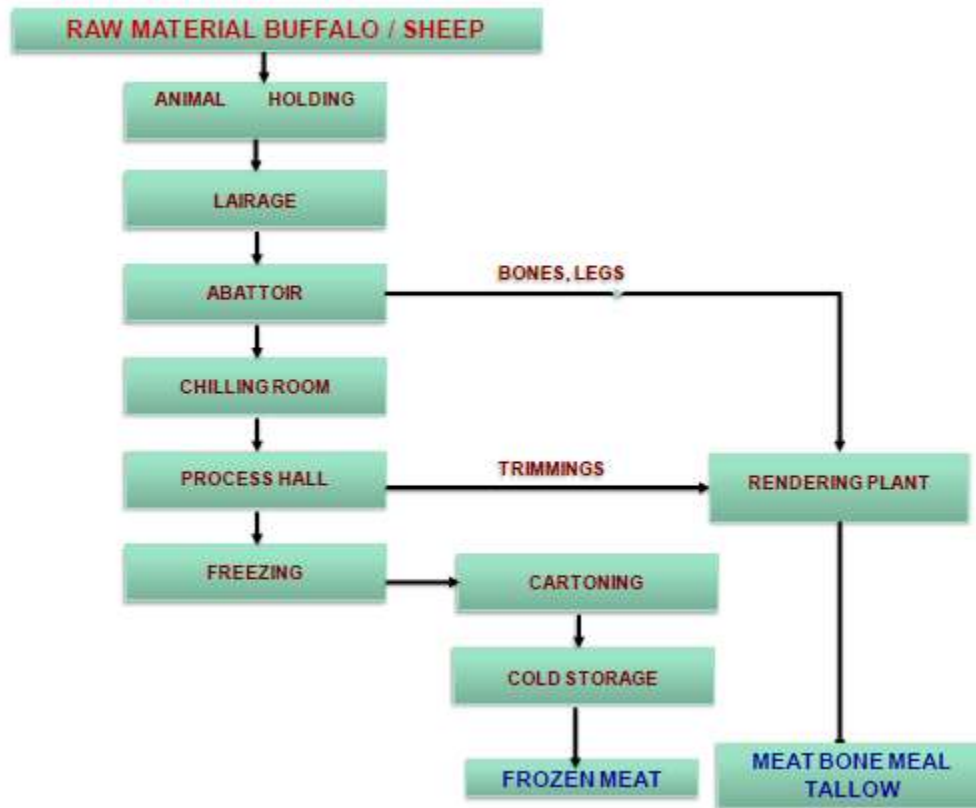

Figure 9 Typical process flow diagram of slaughter house process

3.1.1 Animal holding

The animals are unloaded from the trucks and are allowed to stay in the holding area before slaughtering. The fitness of an animal for slaughter by anti-mortem examination for zoonotic or epidemiological diseases is carried out by veterinary doctors. The rejected animals are isolated from the healthy animals. The selected animals are given adequate care and attention during this pre-slaughter session.

3.1.2 Lairage

The selected animals from the animal holding are moved into the lairage where they are held for 24 hours without food. They are provided only water.

3.1.3 Abattoir / Slaughterhouse

The sheep/goat and buffaloes are slaughtered and processed separately. From lairage, the animals are moved to abattoir and made unconscious with pneumatic gun or dummy bullets / guns. After it becomes unconscious, it is lifted and connected to conveyor arrangements. During movement of the animals in the conveyor various operations are carried out. First, slaughter is done as per halal/standard procedure as most of the products are expected to

West Asian Muslim countries. After bleeding of blood the head, legs, horns, hide or skins are removed manually. Later the stomach paunch and liquor are separated and the carcass is split with the carcass cutter. The carcass is then washed and transported through a conveyor to the chilling room.

The wastes generated in an abattoir are blood, meat scrap, carcass washings, machine and floor washings. In some slaughter houses blood is separated from other wash water, collected and managed individually. The wash water of carcass, machines and floor contains blood, meat scrap and fat.

3.1.4 Chilling room

In the chilling process, the carcass is hung to a conveyor which passes through a chilling tunnel, when the carcass comes out of the tunnel its temperature is reduced to less than 7°C. There are no wastes generated in this process.

3.1.5 Processing

The chilled carcass is moved into the process hall where it is deboned and cut into pieces and packed into cartons according to customer requirements. Bones, meat trimmings and fat are the solid wastes generated during processing which are sent to the rendering plant. The washing of tables, knives, trays and floor contributes to waste water.

3.1.6 Freezing

Products are frozen in plate/tunnel freezer at -40°C so that core temperature reaches -18°C

3.1.7 Cold storage

The packed meat products are stored in cold storage at -20°C until products are dispatched.

3.1.8 Rendering

The waste meat and inedible portions of the animal bodies like cartilage, bones, fat etc. are put into rendering process, where they are crushed and steam cooked to separate fat and then decanted. The fat is sold as inedible tallow, which is used for manufacturing soaps. Rendering process is a major source of effluent and contributes considerable organic load in the plant effluent.

The (glue) water is generated and separated from fats. The glue water contains about 75 percent of the total protein content of rendering input and therefore is a major source of BOD. It has been estimated that the average BOD of glue water stream is 32,000 mg/L. The grease is another component of glue water that is usually separated from water in grease traps. This separated fat can be disposed on land after composting.

3.2 EFFLUENT GENERATION FROM SLAUGHTER HOUSE

Slaughter houses require fresh and potable water for almost all washing and rinsing operations. Water consumption details for slaughtering of large and small animal is shown in the following [Table 1](#). All water used in slaughter is generated as wastewater. Sources of wastewater generation from slaughter house are given [Table 2](#). Quantity of water required is more in the case of mechanized system as compared to manual slaughtering. The water consumption also varies depending on the size of the slaughter house i.e. large slaughter house require less water when compared to small slaughter houses for large animals. However, the water requirement does not much vary in slaughterhouses for small animals.

Table 1 Water consumption details

Animal	Category	Specific water consumption M ³ / TLWK
Buffalo	Large	0.30 – 0.50
	Medium	0.1 – 0.25
	Small	0.05 – .25
Goat / Sheep	Large	1.2 – 2.1
	Medium	1.3 – 2.5
	Small	0.8 – 1.7

Table 2 Sources of effluent generation

Source	Liquid waste
Animal holding	Floor washings & urine
Abattoir	Blood, Floor & machine washings
Cleaning Internal Organs	Wash liquor
Rendering	Glue water
Carcass dressing	Blood, floor& machine washings
By products plant	Floor& machine washings

Typical characteristics of slaughter house wastewater are given in [Table 3](#). Wastewater discharged from slaughterhouse contains high BOD, COD and TSS concentrations and treated fully or partially in effluent treatment plant depending upon the location, capacity and type of slaughterhouses and the treated effluent is disposed into sewer system.

Table 3 Typical Characteristics of Slaughter house wastewater

S.No	Parameter	Raw effluent
1	pH	7.6 – 8.2
2	Total Suspended solids (mg/L)	1500 – 4500
3	Biochemical Oxygen Demand (BOD)(mg/L)	1200 – 4000
4	Chemical Oxygen Demand (COD) (mg/L)	3000 – 7000

3.3 SOLID WASTE GENERATION FROM SLAUGHTER HOUSE

Carcasses are the main products of slaughter house. Other offals are by-products or wastes. Generally, the terms by-products and offal are used to denote every part which is not included in a dressed carcass. By-products can be divided into two groups namely, edible and inedible. Organs such as kidneys, brain, liver, heart, gullet are examples of edible by-products. Hooves, horns, hair, bristles, gall bladder, ears, skin etc. are among the inedible by-products. By-products can form a part of edible meat or can be converted to produce items for various commercial usages. The components left unrecovered simply form the solid wastes. Sources of solid waste generated from slaughter house are given in [Table 4](#). It has been observed that waste generation is largely influenced by the facility for recovery of by-products. Hence, quantity of wastes varies from place to place.

Rumen, stomach and intestinal contents essentially form solid waste. Besides this, stomach and intestine are also disposed of as waste in most of the slaughter houses. Soft meat parts such as lungs and pancreas are collected in large slaughter houses for sale to poultry feed processing units, whereas these offals are disposed as waste in medium and small slaughter houses. Horns and hooves are generally collected for sale.

Table 4 Sources of solid wastes

Source	Solid waste
Animal holding	Fodder wastes / dungs
Abattoir	Blood clots
Hide removal	Hair and dirt
Internal Organ cleaning area	Paunch content
Carcass dressing	Flesh, grease
By products plant	Grease and offal

There are various methods available for treatment and disposal of solid wastes. Composting is usually adopted as treatment for disposal on land. But method has certain disadvantages, which are as follows:

- Demands vast area for composting.
- Extensive manual labour and drudgery in collection of wastes.
- Requires longer time
- Operation of composting facility during monsoon is difficult.
- Fertilizer value is moderate.

The solid wastes generated from the meat processing plants viz. dungs, paunch content, agriculture wastes, waste fat, waste meat etc. have large potential for biomethanation. Typical characteristics of solid waste generated from slaughter house are given in [Table 5](#).

Table 5 Typical Characteristics of Solid wastes

Parameter	Value
Moisture content	60 - 85%
Total solids	15 - 40%
Total Volatile solids	70 - 92%
Organic carbon	22 - 28%
Total Nitrogen	2.5 - 4.2%
Phosphorous	0.2 - 0.4%
Potassium	0.3 - 0.4%

3.4 ENVIRONMENTAL IMPACTS OF WASTE DISPOSAL

The most significant environmental issues associated with slaughterhouse operations are water consumption, emissions of high organic strength liquids to water and the energy consumption associated with refrigeration and water heating.

3.4.1 Water

The most significant environmental impact resulting from slaughterhouses is the effluent. High water consumption and high BOD, COD and TSS concentrations arise during slaughter and carcass dressing. Solids break down and releasing colloidal and suspended fats and solids lead to an increase in the BOD and COD. Other key contaminants are nitrogen and phosphorus from breakdown of proteins, feed residues, and chlorides from hides/skins salting. The excessive use of water is an environmental issue in itself. Blood has the highest COD strength of any liquid effluent arising from animal slaughter houses. The potential contamination of water needs to be considered from the process and from all potential sources ranging from small leaks to major technical and operational accidents. Municipal sewer will be choked or over loaded if wastes from slaughterhouses are discharged without basic treatment.

Waste water may be fully or partially treated in the treatment plant of the slaughterhouse. If treatment is undertaken at a municipal treatment plant, then some pre-treatment must be done at the slaughterhouse. The contamination of waste water can be minimized by collecting by-products and waste as close to the source as possible, and by preventing their mixing with water. Minimizing water use in slaughter and carcass dressing can also reduce the actual contaminant load by reduced opportunities for the entrainment of organic matter such as fat or faeces. If by-products are entrained in water, the opportunities for their re-use are limited. The opportunities for eliminating or reducing water use need to be explored at each unit operation.

In any slaughterhouse, an important factor affecting water consumption is the amount of floor area used. For hygiene reasons, all process floor areas must be washed down at least once a day. Water consumption is, therefore, dependent on the layout of individual slaughterhouses, and also depends on the size of the animal, the method of slaughter, carcass dressing, carcass cooling and the degree of automation. Large quantities of water are consumed in slaughterhouses for evisceration, cleaning and washing operations.

3.4.2 Air

Most emissions to air from slaughterhouses are from the boilers used to raise hot water and steam. There is also a chance of release of refrigerant gases from chilling and freezing plants and CO₂ from stunning equipment. These issues are common throughout much of the food processing industries. Dust is emitted during unloading of animals in the slaughterhouse.

3.4.3 Solid waste

Solids waste generated from slaughterhouses such as cow dung, intestine, solids from effluent treatment plant may be found unscientifically disposed of which attract flies, dogs and other vermin, leads to leachates problem, contamination of surface and ground water thus causing public nuisance and also accompanied by danger of spreading disease.

3.4.4 Odour

Odours can emit from blood storage and handling, slurry, occupied lairages and inedible offal storage are reported to be the most problematic. Yard areas, unwashed by-products containers and treatment plants, including the initial screening of solids, are also reported to be potential problem sources.

3.5 ENVIRONMENTAL GUIDELINES AND STANDARDS FOLLOWED IN OTHER COUNTRIES

Discharge standards for slaughter houses adopted in various countries have been collected and given in [Table 6](#). It was observed that most of the countries have discharge standards for important parameters like pH, BOD, COD, suspended solids, oil and grease. Few developed countries like USA and Ireland has standards for total nitrogen and total phosphorous also and few developing countries China and Ethiopia have discharge limit for total phosphorous. Most of the countries have BOD discharge limit in the range of 20-80 mg/L except Australia where it is 300 mg/L. Similarly, the COD limit varies from 60 - 250 mg/L in most of the countries except Australia where it is three time of BOD discharge limit i.e. 900 mg/L. most of the countries have discharge limit of Oil and grease in the range of 10-15 mg/L except Australia (<200 mg/L).

Table 6 Standards adopted for slaughter house effluent in other countries

Parameter	Ireland	USA	Iran	Ethiopia	China	Australia
pH	6.0-9.0	6.0-9.0	6.5-8.5	6-9	6.0-9.0	6.0-9.0
BOD ₅	>90% removal, or 20 - 40mg/1	50	30	80	20	300
COD	>75% removal, or 125 - 250mg/1	250	60	250	100	900
Suspended Solids	60mg/1	50	60		70	< 1500
Total Ammonia (as N)	10mg/1				15	
Total Nitrogen (as N)	>80% removal, or 15 - 40mg/1	10	-	-	-	
Total Phosphorus (as P)	>80% removal, or 2 - 5mg/1	2		5	0.5	
Oils, Fat and Grease	10 - 15mg/1	10	10	15		< 200

3.6 BEST AVAILABLE TECHNOLOGY (BAT)

Best available technology (BAT) approach is used to limit pollutant discharges with regard to the abatement strategy. This term constitutes a moving target based on technological advancement and best practices, since developing societal values and advancing techniques may change what is currently regarded as "reasonably achievable", and "best available". All the best available technological units i.e., various treatment units adopted for the treatment of slaughter house wastewater has been described below.

3.6.1 Primary treatments

Waste water from process areas at slaughterhouses is normally screened, to both remove organic debris such as hairs, some fats, tissue, paunch and gross solids and to avoid blockages in the Wastewater Treatment Plant (WWTP). Apart from the by-products of actual slaughtering the wastewater generally contains primary solids produced during transport, lairage and the washing of stomachs and intestines. These include straw, feces, urine and intestinal contents.

3.6.1.1. Screening

Screening is the first unit operation used at wastewater treatment plants (WWTPs). Screening removes objects such as rags, paper, plastics, and metals to prevent damage and clogging of downstream equipment, piping, and appurtenances. Some modern wastewater treatment plants use both coarse screens and fine screens.

Coarse Screens: Coarse screens remove large solids, rags, and debris from wastewater, and typically have openings of 6 mm (0.25 in) or larger. Types of coarse screens include mechanically and manually cleaned bar screens, including trash racks. [Table 7](#) describes the various types of coarse screens.

Table 7 Details of coarse screens

Screen Type	Description	Opening size
Trash Rack	Designed to prevent logs, timbers, stumps, and other large debris from entering treatment processes.	38 to 150 mm (1.5-6 in)
Manually Cleaned Bar Screen	Designed to remove large solids, rags, and debris. Bars set at 30 to 45 degrees from vertical to facilitate cleaning. Primarily used in older or smaller treatment facilities, or in bypass channels.	30 to 50 mm (1 to 2 in)
Mechanically Cleaned Bar Screen	Designed to remove large solids, rags, and debris. Bars set at 0 to 30 degrees from vertical. Almost always used in new installations because of large number of advantages relative to other screens.	6 to 38 mm (0.25 to 1.5in).

Fine Screens: Fine screens are typically used to remove material that may create operation and maintenance problems in downstream processes, particularly in systems that lack primary treatment. Typical opening sizes for fine screens are 1.5 to 6 mm (0.06 to 0.25 in). Very fine screens with openings of 0.2 to 1.5 mm (0.01 to 0.06 in) placed after coarse or fine screens can reduce suspended solids to levels near those achieved by primary clarification.

The use of fine screens for grit removal and as a replacement (and a means of upgrading the performance of) for primary sedimentation tanks is increasing. The three most common types of screens used for this purpose are the inclined self-cleaning type, the rotary drum type, and the rotary disk screen. From information on a number of full-scale installations, it appears that grit removals of 80 to 90 percent, BOD₅ removals of 15 to 25 percent, and suspended solids removals of 15 to 30 percent can be achieved with the inclined and rotary drum screens. Suspended solids and BOD removals of 40 -50 and 25-35 percent, respectively have been achieved with the rotary disk screen. Where fine screens are used as alternatives to primary sedimentation basins, the secondary facilities must be sized appropriately to handle the solids and BOD₅.

As discussed above, most large facilities use mechanically cleaned screening systems to remove larger materials because they reduce labor costs and they improve flow conditions and screening capture. Typically, only older or smaller treatment facilities use a manually cleaned screen as the primary or only screening device. A screening compactor is usually situated close to the mechanically cleaned screen and compacted screenings are conveyed to a dumpster or disposal area. However, plants utilizing mechanically cleaned screens should have a standby screen to put in operation when the primary screening device is out of service. This is standard design practice for most newly designed plants.

The use of fine screens in preliminary treatment has experienced resurgence in the last 20 years. Such screens were a common feature before 1930 but their use diminished because of difficulty in cleaning oils and grease from the screens. In the early 1980s, fine screens regained popularity because of improved materials.

Advantages

Manually cleaned screens require little or no equipment maintenance and provide a good alternative for smaller plants with few screenings. Mechanically cleaned screens tend to have lower labour costs than manually cleaned screens and offer the advantages of improved flow conditions and screening capture over manually cleaned screens.

Disadvantages

Manually cleaned screens require frequent raking to avoid clogging and high backwater levels that cause buildup of a solids mat on the screen. The increased raking frequency increases labor costs. Removal of this mat during cleaning may also cause flow surges that can reduce the solids-capture efficiency of downstream units. Mechanically cleaned screens are not subject to this problem, but they have high equipment maintenance costs.

3.6.1.2 Dissolved Air Floatation (DAF)

Floatation is a unit operation used to separate solid or liquid particles from a liquid phase. Separation is brought about by introducing fine gas (usually air) bubbles into the liquid phase. The bubbles attach to the particulate matter, and the buoyant force of the combined particle and gas bubbles is great enough to cause the particle to rise to the surface. Particles that have a higher density than the liquid can thus be made to rise. The rising of particles with lower density than the liquid is enhanced (e.g., oil suspension in water).

In dissolved air floatation (DAF) systems, air is dissolved in the wastewater under a pressure of several atmospheres, followed by release of the pressure to the atmospheric level. In small pressure systems, the entire flow may be pressurized by means of a pump to 275 to 350 kPa with compressed air added at the pump suction. The entire flow is held in a retention tank under pressure for several minutes to allow time for the air to dissolve. The pressurized flow is then admitted through a pressure-reducing valve to the floatation tank where air comes out of solution in minute bubbles throughout the entire volume of liquid.

In the larger units, a portion of the DAF effluent (15% to 120%) is recycled, pressurized, and semi-saturated with air. The recycled flow is then mixed with the unpressurized main stream just before admission to the floatation tank, with the result that the air comes out of solution in contact with particulate matter at the entrance to the tank. Pressure type units have been used mainly for treatment of industrial wastes and for concentration of sludge.

Once the particles have been floated to the surface, they can be collected by a skimming operation. Incoming effluent may require pre-treatment as necessary; for example the addition of chemical coagulant(s) and/or flocculent(s) may be required with associated mixing and coagulation/flocculation stages. Adjustment of pH may also be necessary to ensure optimum operating conditions.

The incoming effluent enters the flotation vessel where it comes into contact with recycled, treated effluent (sometimes termed 'white water'). The percentage of the total effluent flow into which air is dissolved under pressure and subsequently recycled will be determined by several factors. Increasing the pressure within the vessel where the air is being dissolved ensures that a higher concentration of air dissolves into the liquid phase than is possible at atmospheric pressure.

Once this saturated effluent enters the flotation tank, the pressure is released back to atmospheric pressure. This immediately results in the recycled flow becoming supersaturated, generating micro bubbles as the dissolved air comes back out of solution.

These bubbles attach to, and form within, the solids or chemical flocculants entering the vessel, causing them to float to the surface where they are retained and subsequently removed by a mechanical skimmer. Within the rectangular flotation tank, the skimmer mechanism consists of a series of paddles or 'flights' which run on a plastic corrosion-resistant chain, and skim just below the surface of the tank removing the 'float' into a trough for recovery of the sludge. To eliminate the risk of sludge build-up on the flotation tank floor, the design may also incorporate a floor scraper. The DAF system is used in many industrial applications, including dairy waste, process waters, food processing waste, wastewaters and abattoir.

Advantages

The principal advantage of floatation over sedimentation is that very small or light particles that settle slowly can be removed more completely and in a shorter time. Other advantages of dissolved air floatation process are described in the following:

- High loading rate typically 10-20 m³/h.
- Very thick float (sludge) product: Typically 2-3% total solids float can be achieved using hydraulic or mechanical skimming devices. Float can be dewatered without intermediate thickening.
- Often, no polymer is required, as a DAF does not require a large, dense floc. Coagulant dosages may also be reduced in some circumstances.

- Shorter flocculation times, as compared to gravity separation are possible, because a smaller floc particle size is required.
- Rapid start-up, typically <30-60 min to reach steady state, depending on size
- Excellent algae removal efficiencies.
- Excellent *Giardia* and *Cryptosporidium* removal efficiencies (~ 2- 2.5 log), depending on temperature
- Smaller footprint required as compared to conventional flocculation and gravity sedimentation

Disadvantages

- Requires a cover or housing to protect the float layer from wind and precipitation
- Mechanically more complex than conventional gravity clarifiers
- More power intensive as compared to conventional flocculation and sedimentation (2.5 – 3.0 to 0.75 – 1 kWh/10³ m³.d)
- Generally not well suited for clarification of high turbidity silt laden waters
- Because DAF is more mechanically intensive, may not be suitable for locations where equipment maintenance is likely to be neglected.

3.6.1.3. Oil & Grease Trap

Oil & Grease trap is one of the treatment units, built as a reservoir, to remove fats, oil and greasy substances from the wastewater. Baffles in the reservoir retain the wastewater long enough for the grease to congeal and rise to the surface. The grease can then be removed and disposed of properly.

Flow from the wastewater tank enters the grease trap. An approved flow control or restricting device is installed to restrict the flow to the grease trap to the rated capacity of the trap. An air intake valve allows air into the open space of the grease trap to prevent siphon age and back-pressure. The baffles help to retain grease toward the upstream end of the grease trap since grease floats and will generally not go under the baffle. This helps to prevent grease from leaving the grease trap and moving further downstream where it can cause blockage problems. Solids in the wastewater that do not float will be deposited on the bottom of the grease trap and will need to be removed during routine grease trap cleaning. Oil and grease floats on the water surface and accumulates behind the baffles. The oil and grease will be removed during routine grease trap cleaning or continuously through a launder placed inside the baffle at a level little higher than that of the outflow weir. Air relief is provided to maintain proper air circulation within the grease trap. Some grease traps have a sample point at the outlet end of the trap to sample the quality of the grease trap effluent. A cleanout is provided at the outlet or just downstream of the outlet to provide access into the pipe to remove any blockages. The water exits the grease trap through the outlet pipe and continues on to the next treatment unit.

Advantage

- Separation of oil and grease from wastewater can improve the performance of downstream treatment systems.

Disadvantage

- Oil and Grease traps need to be emptied or pumped out periodically

3.6.1.4 Primary Settling Tank

These are large tanks which are designed to allow the wastewater to flow slowly through in a smooth motion, free from turbulence, enabling the solids to settle to the bottom. Retention time in the primary tanks is two to three hours. The sludge is collected by two parallel, chain-driven flight scrapers. These move continuously along the sloping floors of the tanks, slowly ploughing the sludge towards the end of the tank where a cross collector (also chain and flight) moves the sludge into a deep hopper. From here, it is removed by new centrifugal pumps to a sludge pump.

Scum, which rises to the surface of the tanks is lifted over a wall and into a trough by rotating scum collectors and carried into the sludge sump. The sludge and scum from the primary sedimentation tanks are pumped to the gravity thickeners. After the sludge has been thickened in the gravity thickeners, it is sent to the gravity belt thickeners, for further thickening before being sent to the digesters. At this stage, over 70 percent of the suspended solids have been separated from the liquid waste stream with 40 percent of the BOD removed.

There are basically three types of settlement or sedimentation tanks: Upward flow, Horizontal flow, and radial flow.

Upward flow tanks can be circular or square. Horizontal flow tanks are rectangular and compact, but the length of the outlet weir is limited. Radial flow tanks are circular and then occupy more land. They may have their performance affected by flow changes, but have a long perimeter outlet weir. Both circular and rectangular tanks, when of medium or large sizes, will be equipped with sludge and scum collection device. This device is generally made of an overhead bridge, on which bottom and surface scrapers are fixed.

Rectangular (horizontal flow) tanks: Uniform flow should occur between the inlet and the outlet. Settled material is removed either by a continuous belt scraper, or by an overhead bridge scraper, which moves up and down the tank. The bottom of the tank is usually sloped about 1 in 100 to assist sludge movement into the collecting hopper, which is usually at the inlet end, where most deposition occurs. Transverse cross collectors are often installed in the sludge collection trough or hopper, to scrape the sludge to the bled off point.

Advantages

Rectangular tanks are more compact than radial flow tanks, and are less susceptible to flow disturbances.

Disadvantages

Disadvantage is the limited length of outflow weir available. Complicated weir arrangements may be needed.

Circular (radial flow) tanks: Circular tanks can have diameters up to 50 m. The effluent enters in a central distribution well in which this is designed to distribute the flow evenly in all directions. Material which settles out is scraped down the tank bottom (usually sloped at about 1:15) into a central sump. Scraping equipment is supported and operated from a central pier in larger tanks (over 12m diameter), and often simply spans smaller tanks.

Advantages

They do have an advantage in the long length of outflow weir available around the perimeter and consequently are more efficient.

Disadvantages

- Smaller circular tankface constructional difficulties
- Longer circular tank are susceptible for flow disturbance.

3.6.1.5. Tube settler

Tube settlers have been developed as an alternative to shallow basins and are used in conjunction with both existing and specially designed sedimentation basins. They are shallow settling devices consisting of stacked off-set trays or bundles of small plastic tubes of various geometries. They are used to enhance the settling characteristics of sedimentation basins. The tube settlers are inserted in the sedimentation basins of sufficient depth. The flow within the basin passes upward through the plate or tube modules and exits from the basin above the modules. The solids that settle out within the tubes move by means of gravity counter currently downward and out of the tube modules to the basin bottom. To be self-cleaning, tube settlers are usually set at an angle between 45° and 60° above the horizontal. When the angle is increased above 60° the efficiency decreases. If the tubes are inclined at angles less than 45°, sludge will tend to accumulate within the tubes. To control biological growths and the production of odours, the accumulated solids must be flushed out periodically.

Advantages

- Higher slope facilitates gravity drainage of sludge
- Suitable for higher capacity installations

Disadvantages

The principal problems are clogging and odours due to biological growths and the buildup of oil and grease. The need for flushing poses a problem with the use of tube settlers where the characteristics of the solids to be removed vary from day to day.

3.6.1.6. Electro-coagulation

The Electro Coagulation (EC) process operates on the base of the principle that the cations produced electrolytically from iron and/or aluminum anodes, which is responsible for the increasing of the coagulation of contaminants from an aqueous medium. Electrophoretic motion tends to concentrate negatively charged particles in the region of the anode and positively charged particles in the region of the cathode. The consumable metal anodes are used to continuously produce polyvalent metal cations in the region of the anode. These cations neutralize the negative charge of the particles moved towards the anodes by production of polyvalent cations from the oxidation of the sacrificial anodes (Fe and Al) and the electrolysis gases like Hydrogen evolved at the anode and oxygen evolved at the cathode.

Advantages

EC requires simple equipment and is easy to operate with sufficient operational latitude to handle most problems encountered on running. Wastewater treated by EC gives palatable, clear, colorless and odorless water. Sludge formed by EC tends to be readily settleable and easy to de-water, because it is composed of mainly metallic oxides/hydroxides. Floccs formed by EC are similar to chemical floc, except that EC floc tends to be much larger, contains less bound water, is acid-resistant and more stable, and therefore, can be separated faster by filtration. EC produces effluent with less TDS content as compared with chemical treatments. If this water is reused, the low TDS level contributes to a lower water recovery cost. The EC process has the advantage of removing the smallest colloidal particles, because the applied

electric field sets them in faster motion, thereby facilitating the coagulation. The EC process avoids uses of chemicals and so there is no problem of neutralizing excess chemicals and no possibility of secondary pollution caused by chemical substances added at high concentration as when chemical coagulation of wastewater is used. The gas bubbles produced during electrolysis can carry the pollutant to the top of the solution where it can be more easily concentrated, collected and removed by a motorised skimmer. The electrolytic processes in the EC cell are controlled electrically and with no moving parts, thus requiring less maintenance. Due to the excellent EC removal of suspended solids and the simplicity of the EC operation, tests conducted, it was that the most promising application of EC was found to be as pretreatment to a multi-membrane system of UF/RO or microfiltration/reverse osmosis (MF/RO). In this function the EC provides protection of the low-pressure membrane that is more than that provided by chemical coagulation and more effective. EC is more effective at removing species that chemical coagulation and other alternatives can remove and it removes many species that chemical coagulation cannot remove.

Disadvantages

In some EC systems, an impermeable formation of oxides film form on the cathode, so affecting the efficiency of electrocoagulation cell. High conductivity of the waste water suspension is required. Gelatinous hydroxide may tend to solubilised in some cases. Due to oxidation, sacrificial anode dissolved in the waste water, so need to be regularly replaced. The use of electricity may be expensive in some cases.

3.6.1.7. Clariflocculator

The big advantage of this flocculator is the reduction in detention time and elimination of mechanical equipment. The problem of occasional clogging of the flocculation can be overcome at a nominal additional cost by providing arrangements for high velocity upwash using wash water from filter. The cost of structures and equipment for dosing chemicals is not considered here as this forms only a small percentage of the cost of the plant. Moreover, it is possible to fabricate economically simple manually adjustable equipment locally.

3.6.2 Secondary Treatments

3.6.2.1. Upflow Anaerobic Sludge Blanket (UASB)

In the upflow anaerobic sludge blanket process, the waste to be treated is introduced in the bottom of the reactor. The wastewater flows upward through a sludge blanket composed of biologically formed granules or particles. Treatment occurs as the wastewater comes in contact with the granules. The gases produced under anaerobic conditions (principally methane and carbon di oxide) cause internal movements, which helps in the formation and maintenance of the biological granules. The free gas and the particles with the attached gas rise to the top of the reactor. The particles that rise to the surface strike the bottom of the degassing baffles, which causes the attached gas bubbles to be released. The degassed granules typically drop back to the surface of the sludge blanket. The free gas and the gas released from the granules is captured in the gas collection domes located in the top of the reactor. Liquid containing some residual solids and biological granules passes into a settling chamber, where the residual solids are separated from the liquid. The separated solids fall back through the baffle system to the top of the sludge blanket. To keep the sludge blanket in suspension, upflow velocities in the range of 0.6 – 0.9 m/h have been used.

Advantage

- High reduction in organics.
- Can withstand high organic loading rates (up to 10kg BOD/m³/d) and high hydraulic loading rates.
- Low production sludge (and thus, infrequent desludging required).
- Biogas can be used for energy (but usually requires scrubbing first).

Disadvantage

- Difficult to maintain proper hydraulic conditions (upflow and settling rate must be balanced).
- Longer start up time.
- Treatment may be unstable with variable hydraulic and organic loads.
- Constant source of electricity is required.
- Requires expert design and construction supervision.

3.6.2.2. Trickling Filter (TF)

The trickling filter consists of a bed of a highly permeable medium to which microorganisms are attached and through which wastewater is percolated or trickled –hence the name. The filter media usually consist of either rock or a variety of plastic packing materials. In rock filled trickling filters, the size of the rock typically varies from 25 to 100 mm in diameter. The depth of the rock varies with each particular design but usually ranges from 0.9 to 2.5 m and average 1.8 m. Rock filter beds are usually circular, and the liquid wastewater is distributed over the top of the bed by a rotary distributor.

Trickling filters that use plastic media have been built in round, square, and other shapes with depths varying from 4 to 6 m. Three types of plastic media are commonly used:

- 1) Vertical flow packing
- 2) Cross flow packing and
- 3) A variety of random packings.

Filters are constructed with an underdrain system for collecting the treated wastewater and any biological solids that have become detached from the media. Thus underdrain system is important both as a collection unit and as a porous structure through which air can circulate. The collected liquid is passed to a settling tank where the solids are separated from the treated wastewater. In practice, a portion of the liquid collected in the underdrain system or the settled effluent is recycled, usually to dilute the strength of the incoming wastewater and to maintain the biological slime layer in a moist condition.

The organic material present in the wastewater is degraded by a population of microorganisms attached to the filter media. Organic material from the liquid is adsorbed onto the biological slime layer (0.1 to 0.2 mm), the organic material is degraded by aerobic microorganisms. As the microorganisms grow, the thickness of the slime layer increases, and the diffused oxygen is consumed before it can penetrate the full depth of the slime layer. Thus, an anaerobic environment is established near the surface of the media.

As the slime layer increases in thickness, the adsorbed organic matter is metabolized before it can reach the microorganisms near the media face. As a result of having no external organic source available for cell carbon, the microorganisms near the media face enter into an endogenous phase of growth and lose their ability to cling to the media surface. The liquid then washes or slime off the media, and a new slime layer starts to grow. This phenomenon of losing the slime layer is called “sloughing” and is primarily a function of the organic and hydraulic loading on the filter. The hydraulic loading accounts for shear velocities, and the organic loading accounts for the rate of metabolism in the slime layer. In trickling filter, the hydraulic loading rate is adjusted to a slime layer of uniform thickness.

Advantages

- Simple, reliable, biological process.
- Suitable in areas where large tracts of land are not available for land intensive treatment systems
- May qualify for equivalent secondary discharge standards.
- Effective in treating high concentrations of organics.
- Appropriate for small- to medium-sized communities.
- Rapidly reduces soluble BOD in applied wastewater.
- Efficient nitrification units.
- Low power requirements.
- Moderate level of skill and technical expertise needed to operate the system.

Disadvantages

- Additional treatment may be needed to meet more stringent discharge standards.
- Possible accumulation of excess biomass that cannot retain an aerobic condition and can impair TF performance (maximum biomass thickness is controlled by hydraulic dosage rate, type of media, type of organic matter, temperature and nature of the biological growth).
- Incidence of clogging is relatively high.
- Control is limited in comparison with activated-sludge processes.
- Vector and odor problems.
- Snail problems.

3.6.2.3. Rotating Biological Contactor

A rotating biological contactor consists of a series of closely spaced circular disks of polystyrene or polyvinyl chloride. The disks are partially submerged in wastewater and rotated slowly through it.

In operation, biological growth attaches to the surfaces of the disks and eventually form a slime layer over the entire wetted surface area of the disks. The rotation of the disks alternately contacts the biomass with the organic material in the wastewater and then with the atmosphere for adsorption of oxygen. The disk rotation affects oxygen transfer and maintains the biomass in an aerobic condition. The rotation is also the mechanism for removing excess solids from the disks by shearing forces it creates and maintaining the sloughed solids in suspension so they can be carried from the unit to a clarifier. Rotating biological contactors can be used for secondary treatment, and they can also be operated in the seasonal and continuous-nitrification and de-nitrification modes.

Advantages

Rotating biological contactors are quite reliable because of the large amount of biological mass present (low operating Food/Microorganism). This large biomass also permits them to

withstand hydraulic and organic surges more effectively. The effect of staging in this plug flow system eliminates short circuiting and dampens shock loadings.

Disadvantage

- Continuous power requirement
- Maintenance requirement

3.6.2.4. Packed bed reactors

Passing wastewater over fixed or packed bed reactors supporting anaerobic micro-organisms on plastic rings or balls or on sintered glass, can act as a pretreatment technique to reduce the COD in waste water, prior to aerobic treatment. One particular technique operates in either a down-flow or up-flow operation, incorporating recirculation. However, the technique is unable to reduce the COD and nitrogen content sufficiently. It is reported to be capable of removing 50 – 70 % of COD.

Aerobic packed bed reactor is also used for both the removal of carbonaceous BOD and nitrification. Typically, an aerobic packed bed reactor consists of a container (reactor) that is packed with a medium to which the microorganisms can become attached. Wastewater is introduced from the bottom of the container through an appropriate under drain system or inlet chamber. Air or pure oxygen necessary for the process is also introduced with the wastewater.

Advantages

- Partial removal of some of the organic load from wastewater, prior to further treatment thereby reducing the energy demand of ETP.
- Anaerobic backed bed reactors produce biogas which can be used for energy generation.
- Sludge production is reduced.
- Removal of nitrogen also occurs during aerobic process.

Disadvantages

- The ammonia content released from organic nitrogen during anaerobic treatment exceed the nitrogen fixation through new biomass formation, so the level of ammoniacal nitrogen increases during the treatment.

3.6.2.5 Anaerobic digester

Anaerobic process involves decomposition of organic and inorganic matter in absence of molecular oxygen. The major applications have been in stabilization of concentrated sludge produced from treatment of wastewater and in treatment of some industrial wastes.

In anaerobic digestion process, organic material in mixtures of primary settled and biological sludge is converted biologically, under anaerobic conditions, to a variety of end products including methane (CH₄) and carbon di oxide (CO₂). The process is carried out in a reactor. Sludge, introduced continuously or intermittently, is retained in the reactor for varying periods of time. The stabilized sludge, withdrawn continuously or intermittently from the reactor, is reduced in organic and pathogen content and is non-putrescible.

The two types of commonly used anaerobic digesters are identified as standard rate and high rate. In the standard rate digestion process, the contents of the digester are usually unheated and unmixed. Detention times for the standard rate process vary from 30 to 60 days. In a high-

rate digestion process the contents of the digester are heated and mixed completely. The required detention time for high rate digestion is typically 15 days or less.

Anaerobic digestion in high-rate reactors represents an attractive alternative for wastewater treatment at the slaughterhouse plant. First, slaughterhouse wastewater is particularly well suited for anaerobic treatment. It contains high concentrations of biodegradable organics, mostly from fats and proteins, sufficient alkalinity, and adequate phosphorous, nitrogen, and micronutrient concentrations for bacterial growth. It does not include toxic compounds and has a relatively warm temperature between 20°C and 30°C. Secondly, anaerobic digestion provides high COD and suspended solid (SS) removal while producing a recoverable source of energy in the form of methane. It generates very low quantity of sludge and does not require aeration or chemical pre-treatment. Finally, anaerobic bacteria can survive unfed for long periods of time, an important feature for smaller slaughterhouses that operate just a few days a week or close down during slow or holiday periods.

Advantages

- Recovery of energy in the form of biogas
- Reduce pollution load to subsequent aerobic system, thereby reducing the energy demand
- Removal of suspended solids in digester, thereby avoiding primary settling tank.

Disadvantages

- Solids escapes the digester due to the absence of gas liquid solid separator
- Scum formations leads to clogging of pipelines, interference with uniform biogas production and reduction in effective digester volume.

3.6.2.6 Anaerobic lagoon

Anaerobic lagoons are used for treatment of high-strength organic wastewater that also contains a high concentration of solids. Typically, an anaerobic pond is a deep earthen pond with appropriate inlet and outlet piping. To conserve heat energy and to maintain anaerobic conditions, anaerobic lagoons have been constructed with depths up to 4 m. The wastes that are added to the lagoon settle to the bottom. The partially clarified effluent is usually discharged to another treatment process for further treatment.

Usually, anaerobic lagoons are anaerobic throughout their depth, except for an extremely shallow surface zone. Stabilization is brought about by a combination of precipitation and anaerobic conversion of organic wastes to CH₄, CO₂, and other gaseous end products, organic acids and cell tissues. Conversion efficiencies for BOD₅ of upto 70% are obtainable routinely. Under optimum operating conditions, removal efficiencies upto 85% are possible.

Anaerobic ponds are commonly 2 – 5 m deep and receive wastewater with high organic loads (i.e., usually greater than 100 g BOD/m³.day, equivalent to more than 3000 kg/ha.day for a depth of 3 m). They normally do not contain dissolved oxygen or algae. In anaerobic ponds, BOD removal is achieved by sedimentation of solids, and subsequent anaerobic digestion in the resulting sludge. The process of anaerobic digestion is more intense at temperatures above 15°C. The efficiency of anaerobic bacteria drops off rapidly at pH <6.2. Thus, acidic wastewater must be neutralized prior to its treatment in anaerobic ponds. A properly-designed anaerobic pond will achieve about a 40% removal of BOD at 10°C, and more than 60% at 20° C. Retention time of 3 - 8 days is commonly used.

Advantages

- More effective for rapid stabilization of strong organic wastes, making higher influent organic loading possible.
- Produce methane, which can be used to heat buildings, run engines or generate electricity, but methane collection increases operational problems.
- Produce less biomass per unit of organic material processed. Less biomass produced equates to savings in sludge handling and disposal costs.
- Do not require additional energy, because they are not aerated, heated or mixed.
- Less expensive to construct and operate.
- Ponds can be operated in series.

Disadvantages

- Require a relatively large area of land.
- Produce undesirable odors unless provisions are made to oxidize the escaping gases. Gas production must be minimized (sulfate concentration must be reduced to less than 100 mg/L) or mechanical aeration at the surface of the pond to oxidize the escaping gases is necessary. Aerators must be located to ensure that anaerobic activity is not inhibited by introducing dissolved oxygen to depths below the top 0.6 to 0.9 m (2 to 3 feet) of the anaerobic lagoon. Another option is to locate the lagoon in a remote area. Require a relatively long detention time for organic stabilization due to the slow growth rate of the methane formers and sludge digestion.
- Wastewater seepage into the groundwater may be a problem. Providing a liner for the lagoon can prevent this problem.
- Environmental conditions directly impact operations so any variance limits the ability to control the process, (e.g. lagoons are sensitive to temperature fluctuations)
- Emit methane gas which one of the greenhouse gas responsible of global warming.

3.6.2.7 Activated Sludge Process (ASP)

Aeration tanks provide biological treatment of waste water. In these tanks, microorganisms and waste water in various stages of decomposition are mixed, aerated, and maintained in suspension. The contents of the aeration tanks, which require a right balance of food and oxygen, are commonly referred to as the mixed liquor suspended solids (MLSS) or activated sludge. The activated sludge converts organic substances into oxidized products and a settleable floc which is settled in the secondary clarifiers. The aeration tanks have a great deal of flexibility. Raw sewage can be introduced in various locations and be aerated and mixed for varying lengths of time and intensity.

Diffused Aeration: Sewage liquor is run into deep tanks with diffuser grid aeration systems that are attached to the floor. These are like the diffused airstone used in tropical fish tanks but on a much larger scale. Air is pumped through the blocks and the curtain of bubbles formed both oxygenates the liquor and also provides the necessary mixing action. Where capacity is limited or the sewage is unusually strong or difficult to treat, oxygen may be used instead of air. Typically, the air is generated by some type of blower or compressor.

3.6.2.8 Waste Stabilization Ponds (WSP)

Waste Stabilization Ponds (WSPs) are large, shallow basins in which raw sewage is treated entirely by natural processes involving both algae and bacteria. They are used for sewage treatment in temperate and tropical climates, and represent one of the most cost-effective, reliable and easily-operated methods for treating domestic and industrial wastewater. Waste stabilization ponds are very effective in the removal of faecal coliform bacteria. Sunlight is the

only energy requirement for its operation. Further, it requires minimum supervision for daily operation, by simply cleaning the outlets and inlet works. The temperature and duration of sunlight in tropical countries offer an excellent opportunity for high efficiency and satisfactory performance for this type of water-cleaning system. They are well-suited for low-income tropical countries where conventional wastewater treatment cannot be achieved due to lack of a reliable energy source. Further, the advantage of these systems, in terms of removal of pathogens, is one of the most important reasons for its use.

WSP systems comprise a single string of anaerobic, facultative and maturation ponds in series, or several such series in parallel. In essence, anaerobic and facultative ponds are designed for removal of Biochemical Oxygen Demand (BOD), and maturation ponds for pathogen removal, although some BOD removal also occurs in maturation ponds and some pathogen removal in anaerobic and facultative ponds. In most cases, only anaerobic and facultative ponds will be needed for BOD removal when the effluent is to be used for restricted crop irrigation and fish pond fertilization, as well as when weak sewage is to be treated prior to its discharge to surface waters. Maturation ponds are only required when the effluent is to be used for unrestricted irrigation, thereby having to comply with the WHO guideline of <1000 fecal coliform bacteria/100 ml. The WSP does not require mechanical mixing, needing only sunlight to supply most of its oxygenation. Its performance may be measured in terms of its removal of BOD and faecal coliform bacteria.

Facultative ponds

Facultative ponds (1-2 m deep) are of two types: Primary facultative ponds that receive raw wastewater, and secondary facultative ponds that receive particle-free wastewater (usually from anaerobic ponds, septic tanks, primary facultative ponds, and shallow sewerage systems). The process of oxidation of organic matter by aerobic bacteria is usually dominant in primary facultative ponds or secondary facultative ponds.

It is estimated that about 30% of the influent BOD leaves the primary facultative pond in the form of methane. A high proportion of BOD that does not leave the pond as methane ends up in algae. This process requires more time, more land area, and possibly 2 -3 weeks water retention time, rather than 3 - 8 days in the anaerobic pond. In the secondary facultative pond (and the upper layers of primary facultative ponds), sewage BOD is converted into "Algal BOD" and has implications for effluent quality requirements. About 70-90% of BOD of the final effluent from a series of well-designed WSPs is related to the algae they contain.

In secondary facultative ponds that receive particle-free sewage (anaerobic effluent), the remaining non-settleable BOD is oxidised by heterotrophic bacteria (*Pseudomonas*, *Flavobacterium*, *Archromobacter* and *Alcaligenesspp*). The oxygen required for oxidation of BOD is obtained from photosynthetic activity of the micro-algae that grow naturally and profusely in facultative ponds.

Facultative ponds are designed for BOD removal on the basis of a relatively low surface loading (100 - 400 kg BOD/ha.day), in order to allow for the development of a healthy algal population, since the oxygen for BOD removal by the pond bacteria is generated primarily via algal photosynthesis. The facultative pond relies on naturally-growing algae. The facultative ponds are usually dark-green in colour because of the algae they contain. Motile algae (*Chlamydomonas* and *Euglena*) tend to predominate the turbid water in facultative ponds, compared to none-motile algae (*Chlorella*).

The algal concentration in the pond depends on nutrient loading, temperature and sunlight, but is usually in the range of 500 - 2000 µg chlorophyll-a/litre. Because of the photosynthetic activities of pond algae, there is a diurnal variation in the dissolved oxygen concentration. The dissolved oxygen concentration in the water gradually rises after sunrise, in response to photosynthetic activity, to a maximum level in the mid-afternoon, after which it falls to a minimum during the night, when photosynthesis ceases and respiratory activities consume oxygen. At peak algal activity, carbonate and bicarbonate ions react to provide more carbon dioxide for the algae, leaving an excess of hydroxyl ions. As a result, pH of water can rise to above 9, which can kill faecal coliform. Good water mixing, which is usually facilitated by wind within upper water layer, ensures uniform distribution of BOD, dissolved oxygen, bacteria and algae, thereby leading to a better degree of waste stabilization.

Maturation Ponds

The maturation ponds, usually 1-1.5 m deep, receive the effluent from the facultative ponds. Their primary function is to remove excreted pathogens. Although maturation ponds achieve only a small degree of BOD removal, their contribution to nutrient removal can be significant. Maturation ponds usually show less vertical biological and physicochemical stratification, and are well-oxygenated throughout the day. The algal population in maturation ponds is more diverse than that of the facultative ponds, with non-motile genera tending to be more common. The algal diversity generally increases from pond to pond along the series. Although faecal bacteria are partially removed in the facultative ponds, the size and numbers of the maturation ponds especially determine the remaining faecal bacteria in the final effluent. There is some removal of solids-associated bacteria in anaerobic ponds, principally by sedimentation. The principal mechanisms for faecal bacterial removal in facultative and maturation ponds are now known to be:

- a. Time and temperature;
- b. High pH (> 9); and
- c. High light intensity, combined with high dissolved oxygen concentration.

Time and temperature are the two principal parameters used in designing maturation ponds. Faecal bacterial die-off in ponds increases with both time and temperature. High pH values (above 9) occur in ponds due to rapid photosynthesis by pond algae, which consumes CO₂ faster than it can be replaced by bacterial respiration. As a result, carbonate and bicarbonate ions dissociate, as follows:

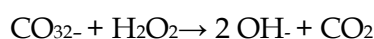
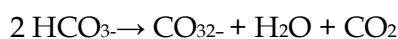

The resulting CO₂ is fixed by the algae, and the hydroxyl ions accumulate, often raising the pH of values above 10. Faecal bacteria (with the notable exception of *Vibrio cholerae*) die very quickly at pH values higher than 9. The role of high light intensity and high dissolved oxygen concentration has recently been elucidated. Light of wavelengths between 425 - 700 nm can damage faecal bacteria by being absorbed by the humic substances ubiquitous in wastewater. They remain in an excited state sufficiently long to damage the cell. Light-mediated die-off is completely dependent on the presence of oxygen, as well as being enhanced at high pH values. Thus, the sun plays a three-fold role in directly promoting faecal bacteria removal in WSP, in increasing the pond temperature, and more indirectly by providing the energy for

rapid algal photosynthesis. This not only raises the pond pH value above 9, but also results in high dissolved oxygen concentrations, which are necessary for its third role; namely, promoting photo-oxidative damage.

Nutrient removal in waste stabilization ponds

In anaerobic ponds, organic nitrogen is hydrolysed to ammonia. Thus, the effluent from anaerobic ponds usually has higher concentrations of ammonia than in wastewater. In facultative and maturation ponds, ammonia is incorporated into algal biomass. At high pH values, ammonia leaves the pond through volatilization. There is little evidence for nitrification (and hence denitrification, unless the wastewater has a high nitrate content). This is due to the fact that the population of the nitrifying bacteria is low because of lack of physical attachment sites in the aerobic zone. Total nitrogen and ammonia removal from WSP can reach 80 and 95%, respectively.

Phosphorus removal in WSP is associated with its uptake by algal biomass, precipitation and sedimentation. However, both nitrogen and phosphorus must be removed in order to prevent eutrophication in receiving water bodies. The common practice in the design of the WSP is not based on nutrient removal; rather, it is based on BOD and fecal coliform removal.

Advantages

- High reduction in pathogens.
- Can be built and repaired with locally available materials.
- Construction can provide short-term employment to local labourers.
- Low operating cost.
- No electrical energy required.
- No real problems with flies or odours if designed correctly

Disadvantages

- Requires expert design and supervision.
- Variable capital cost depending on the price of land.
- Requires large land area.
- Effluent/sludge requires secondary treatment and/or appropriate discharge.

3.6.3 Tertiary treatment

3.6.3.1 Pressure Sand Filter (PSF)

A typical pressure sand filter consists of a pressure vessel - this could be either vertical or horizontal-fitted with a set of frontal pipe work and valves, graded sand supported by layers of graded under bed consisting of pebbles and silex, a top distributor to distribute the incoming water uniformly throughout the cross section of the filter, and an under drain system to collect filtered water.

In pressure sand filter raw water flows down wards through the filter bed and as the suspended matter- which has usually been treated by addition of a coagulant like alum- is retained on the sand surface and between the sand grains immediately below the surface. There is steady rise in the loss of head as the filtration process continues and the flow reduces once the pressure drop across the filter is excessive. The cleaning of the filter is effected by flow reversal. To assist in cleaning the bed, the backwash operation is often preceded by air

agitation through the under drain system. The process of air scouring agitates the sand with a scrubbing action, which loosens the intercepted particles.

Advantages

- Turbid water may be treated
- Land required is less compared to slow sand filter
- Operation is continuous.

Disadvantages

- Requires skilled personnel for operation and maintenance
- Less effective in bacteria removal
- Operational troubles

3.6.3.2 Activated Carbon Adsorption (ACF)

In water and wastewater treatment systems, activated carbon is almost always used as an independent treatment operation. In some cases, powdered activated carbon (PAC) is added to the actual wastewater stream to adsorb contaminants, then removed later from the stream and discarded. Because PAC has a faster adsorption rate, it was often used in the past, but disposal and handling concerns have made granular activated carbon (GAC) a more popular alternative for most applications. GAC is used in the adsorption process in water treatment, then regenerated when it becomes less effective due to saturation with chemicals. GAC is also usually much easier to handle and transport than PAC.

Three primary types of adsorption beds are used with GAC as medium. The differences involve the method by which carbon is removed from the system as its capacity is exhausted. All three require constant monitoring of effluent in order to determine when the 'breakthrough' occurs which is indicated by effluent with a high concentration of solute. This breakthrough, of course, indicates that the carbon is no longer adsorbing effectively.

The simplest system involves a fixed bed column, in which the granular carbon remains stationary in a cylindrical tank while the water flows downward through the granular medium under the force of gravity and is removed from the bottom. With the fixed bed column, the spent carbon is removed after breakthrough by shutting down and draining the tank and new or reactivated carbon is added as a new batch. The trouble associated with this replacement limits the use of this type of system only to situations involving very low influent concentrations and usually relatively low flows.

For situations in which higher influent solute concentrations tend to deplete the carbon life more quickly, a system of multiple beds is often used. This simply involves a sequential arrangement of two or more fixed beds so that water flowing out of one bed enters the top of the next bed or tank. Such a multiple-reactor series usually produces effluent of much higher quality, as large concentrations of solutes are retained by the first bed in the series, while subsequent beds achieve removal of even low levels of contaminants. With this type of system, the beds can be rotated sequentially so that the second bed becomes the first in the system when breakthrough occurs in the first. Of course, any of the beds must be emptied when carbon replacement is necessary, but the presence of multiple filter beds allows more flexibility in doing this.

Advantages

- Highly effective at removing non-polar organic chemicals from water.

- Applicable to a wide variety of organic compounds
- Very effective at removing colors from waste streams.
- Effective at removing low levels (ppb range) of inorganic pollutants.
- Thermal regeneration of the carbon destroys the adsorbed waste solute.
- Very flexible system allows rapid start-up and shut down as needed.
- System can be designed so that it is portable, to be taken to waste sites.

Disadvantages

- Activated carbon effectively removes many chemicals and gases, and in some cases it can be effective against microorganisms. However, generally it will not affect total dissolved solids, hardness, or heavy metals.
- Granular activated carbon can provide a base for the growth of bacteria. When the carbon is fresh, virtually all organic impurities (not organic chemicals) and even some bacteria are removed. Accumulated impurities, though, can become food for bacteria, enabling them to multiply within the filter.
- Chemical recontamination of granular activated carbon filters can occur in a similar way. If the filter is used beyond the point at which it becomes saturated with the impurities it has absorbed, the trapped impurities can release from the surface and re-contaminate the water, with even higher concentrations of impurities than in the untreated water. This saturation point is impossible to predict.
- Granular carbon filters are susceptible to channelling. Because the carbon grains are held (relatively) loosely in a bed, open paths can result from the build-up of impurities in the filter and rapid water movement under pressure through the unit. In this situation, contact time between the carbon and the water is reduced, and filtration is less effective.
- Limited to wastes with low organic concentrations (< 5%).
- Limited to wastes with very low inorganic concentrations (< 1%).
- Unable to remove highly soluble organics, or those with low molecular weights.
- Systems cannot tolerate suspended solids in the influent stream (due to clogging).
- High operating costs due to carbon costs system requirements.
- Disposal of contaminated carbon can be problematic if it is not regenerated.

3.6.3.3 Ultrafiltration (UF)

Ultrafiltration (UF) is one of the pressure-driven membrane processes. The ultrafiltration process uses a membrane – a simple permeable material – which, in the case of ultra-filtration, only allows particles smaller than 20 nm to pass through it. The pore size varies between 100 nm and 20 nm.

Ultrafilter membranes are offered in various configurations by suppliers, with each configuration having a specific use and accompanying advantages and disadvantages. Possible membrane configurations include:

- Pipe-shaped membranes: capillary, hollow fibre or tubular;
- Plate-shaped membranes: flat plate or spiral.

In addition to the specific membrane configurations, one can also identify a few set-ups. The most commonly used methods are dead-end and cross-flow set-ups. The names refer to the way in which the supply is sent to the membrane.

In dead-end UF, the supply is sent directly to the membrane. The pollution layer will thus form on the supply side of the membrane surface. This layer contains all particles that have

been separated on the basis of their size (sieve effect). This layer is periodically rinsed away by briefly re-sending the produced liquid (permeate) through the membrane in an opposite direction to the production flow. This helps to loosen the hardened layer, and makes it ready for disposal. This is referred to as a semi dead-end set-up.

The re-rinsing may not be enough to remove the layer from the surface if the hardened layer is too strongly compressed or if the bond with the membrane is very strong. In this case, chemical cleaning must be implemented with, for example, bleach, peroxide, acid and alkali or detergent.

In a cross-flow set-up, the liquid is passed along the membrane surface at a particular speed. The permeate is able to pass through the membrane and the larger particles are left behind in a concentrated flow (the retentate). The hardened layer in this set-up is continuously removed by the cross-flowing supply flow.

Advantages

- Low operating pressure required (higher than MF);
- Lower energy consumption than nano-filtration or reverse osmosis;
- Few manual actions required;
- Relatively cheap;
- Good permeate yield depending on the supply water and membrane choice;
- Disinfection through removal of bacteria. To a certain extent, UF allows viruses, phage, colloids and macro molecules to be removed.

Disadvantages

- Only removes suspended matter and bacteria;
- Sensitive to oxidative chemicals (e.g. nitric acid, sulphuric acid, peroxide and persulphate in high concentrations); NaOCl exposure determines the life-span of the membrane and is typically 150.000 to 500.000 ppmh and pH dependent;
- Damage may occur when trying to prevent hard and sharp particles > 0.1 mm;
- Membrane damage at pressure > 3 bar.

3.6.3.4 Disinfection / Ozonation

Disinfection is considered to be the primary mechanism for the inactivation/destruction of pathogenic organisms to prevent the spread of waterborne diseases to downstream users and the environment. It is important that wastewater be adequately treated prior to disinfection in order for any disinfectant to be effective. Ozone is produced when oxygen (O₂) molecules are dissociated by an energy source into oxygen atoms and subsequently collide with an oxygen molecule to form an unstable gas, ozone (O₃), which is used to disinfect wastewater. Most wastewater treatment plants generate ozone by imposing a high voltage alternating current (6000 to 20000 volts) across a dielectric discharge gap that contains an oxygen-bearing gas. Ozone is generated onsite because it is unstable and decomposes to elemental oxygen in a short amount of time after generation. Ozone is a very strong oxidant. The mechanisms of disinfection using ozone include:

- Direct oxidation/destruction of the cell wall with leakage of cellular constituents outside of the cell.
- Reactions with radical by-products of ozone decomposition.
- Damage to the constituents of the nucleic acids (purines and pyrimidines).
- Breakage of carbon-nitrogen bonds leading to depolymerization.

When ozone decomposes in water, the free radicals hydrogen peroxy (HO_2) and hydroxyl (OH) that are formed have great oxidizing capacity and play an active role in the disinfection process. It is generally believed that the bacteria are destroyed because of protoplasmic oxidation resulting in cell wall disintegration (cell lysis). The effectiveness of disinfection depends on the susceptibility of the target organisms, the contact time, and the concentration of the ozone. The components of an ozone disinfection system include feed-gas preparation, ozone generation, ozone contacting, and ozone destruction. Air or pure oxygen is used as the feed-gas source and is passed to the ozone generator at a set flow rate. The energy source for production is generated by electrical discharge in a gas that contains oxygen. Ozone generators are typically classified by:

- The control mechanism (either a voltage or frequency unit).
- The cooling mechanism (either water, air, or water plus oil).
- The physical arrangement of the dielectrics (either vertical or horizontal).
- The name of the inventor.

Ozone generators manufactured by different companies have unique characteristics but also have some common configurations. The electrical discharge method is the most common energy source used to produce ozone. Extremely dry air or pure oxygen is exposed to a controlled, uniform high-voltage discharge at a high or low frequency. The dew point of the feed gas must be -60°EC (-76°EF) or lower. The gas stream generated from air will contain about 0.5 to 3.0% ozone by weight, whereas pure oxygen will form approximately two to four times that concentration.

After generation, ozone is fed into a down-flow contact chamber containing the wastewater to be disinfected. The main purpose of the contactor is to transfer ozone from the gas bubble into the bulk liquid while providing sufficient contact time for disinfection. The commonly used contactor types diffused bubble (co-current and counter-current) are positive pressure injection, negative pressure (Venturi), mechanically agitated, and packed tower.

Because ozone is consumed quickly, it must be contacted uniformly in a near plug flow contactor. The off-gases from the contact chamber must be treated to destroy any remaining ozone before release into the atmosphere. Therefore, it is essential to maintain an optimal ozone dosage for better efficiency. When pure oxygen is used as the feed-gas, the off-gases from the contact chamber can be recycled to generate ozone or for reuse in the aeration tank. The ozone off-gases that are not used are sent to the ozone destruction unit or are recycled.

The key process control parameters are dose, mixing, and contact time. An ozone disinfection system strives for the maximum solubility of ozone in wastewater, as disinfection depends on the transfer of ozone to the wastewater. The amount of ozone that will dissolve in wastewater at a constant temperature is a function of the partial pressure of the gaseous ozone above the water or in the gas feed stream. It is critical that all ozone disinfection systems are pilot tested and calibrated prior to installation to ensure they meet discharge permit requirements for their particular sites.

Ozone disinfection is generally used at medium to large sized plants after at least secondary treatment. In addition to disinfection, another common use for ozone in wastewater treatment is odor control. Ozone disinfection is the least used method in the U.S. although this technology has been widely accepted in Europe for decades. Ozone treatment has the ability

to achieve higher levels of disinfection than either chlorine or UV, however, the capital costs as well as maintenance expenditures are not competitive with available alternatives.

Ozone is therefore used only sparingly, primarily in special cases where alternatives are not effective.

Advantages

- Ozone is more effective than chlorine in destroying viruses and bacteria.
- The ozonation process utilizes a short contact time (approximately 10 to 30 minutes).
- There are no harmful residuals that need to be removed after ozonation because ozone decomposes rapidly.
- After ozonation, there is no regrowth of microorganisms, except for those protected by the particulates in the wastewater stream.
- Ozone is generated onsite, and thus, there are fewer safety problems associated with shipping and handling.
- Ozonation elevates the dissolved oxygen (DO) concentration of the effluent. The increase in DO can eliminate the need for reaeration and also raise the level of DO in the receiving stream.

Disadvantages

- Low dosage may not effectively inactivate some viruses, spores, and cysts.
- Ozonation is a more complex technology than is chlorine or UV disinfection, requiring complicated equipment and efficient contacting systems.
- Ozone is very reactive and corrosive, thus requiring corrosion-resistant material such as stainless steel.
- Ozonation is not economical for wastewater with high levels of suspended solids (SS), biochemical oxygen demand (BOD), chemical oxygen demand, or total organic carbon.
- Ozone is extremely irritating and possibly toxic, so off-gases from the contactor must be destroyed to prevent worker exposure.
- The cost of treatment can be relatively high in capital and in power intensiveness.

3.7 BEST PRACTICABLE TECHNOLOGY (BPT)

3.7.1. Primary Treatment

3.7.1.1 Screening

This is the first technique employed in primary treatment, which is the first step in the wastewater treatment process. This step removes all sorts of refuse that arrives with the

wastewater such as plastic, branches, rags, and metals. The screening process is used primarily to prevent clogging and interference of following treatment processes.

Screens are considered coarse if their opening is larger than 6mm, fine if their openings are between 1.5 and 6mm, and very fine if their openings are between 0.2 and 1.5mm

The functions of screening equipment as part of the pre-treatment works area – i) to protect downstream mechanical plant from damage or obstruction due to large objects in the wastewater flow; ii) to separate and remove larger material which might interfere with the efficient operation of wastewater treatment processes; and iii) to ensure absence of unsightly floating matter at outfalls or in receiving waters

In slaughter house wastewater treatment, there are a variety of rotary drum screens available. In some systems the effluent is loaded inside the drum, but more commonly the effluent flows over the external surface of the drum. Rotary drum screens have been reported to typically have a mesh size of between 2 - 4 mm.

Treatment benefit

The rotary drum screen reduces the contribution from solids to the waste water BOD level. It, therefore, reduces the wastewater treatment required. The proportion of the solid to the soluble fraction of the BOD depends on how the water use and the slaughter, carcase dressing and evisceration processes are managed in individual slaughterhouses. BOD reductions of 10 - 15 % have been reported

Economics

Mechanical screens are typically between 5 – 8 times as expensive as static wedge screens, but they have the benefit of being self-cleaned and generally require less maintenance and associated costs.

3.7.1.2 Dissolved Air flotation (DAF)

Flotation plants separate the fat and solids from the waste water. Certain metal salts such as iron (III) sulphate, iron (III) chloride and aluminium sulphate, aluminium chloride and a number of polymers are also used for precipitation and flocculation. The quantity and type of flocculation agents and flocculation aids has to be determined after semi-commercial trials or after construction of a plant. It has been observed that their use is not always necessary. Application of sludge on agricultural land may be restricted after flocculation due to metal salt residues. For this reason, flotation without flocculation and precipitation agents can be selected. Achieving flotation of solid particles requires production of micro-bubbles.

Treatment benefits

Reduction of COD, BOD, nitrogen and phosphorus in wastewater and the production of sludge, for use in biogas production. The cleaning requirements depend on the type of equipment, the characteristics of the wastewater and how it is being operated.

Performance of DAF for slaughter house wastewater

In typical slaughterhouse wastewater treatment, it is reported that COD (ranging from 2900 mg/l to 3800 mg/l) can be reduced by a DAF system to less than 600 mg/l. Similarly, it is reported that suspended solids can be reduced from about 1500 mg/l to less than 100 mg/l. In case of Indian slaughter houses that SS and COD removal of 57% and 45% is observed.

Economics

It has been reported that in many cases, the capital expenditure of a DAF plant is justified by reduced trade effluent costs.

3.7.1.3 Oil & Grease Trap

Traps can capture fat, oil and grease that have been allowed to enter the waste water, by slowing down the flow of the wastewater through the trap, which comprises a tank. If the water is hot, it is allowed to cool. As the water cools, the fat, oil and grease separate out and float to the top of the trap. The cool water continues to flow out of the trap to the WWTP, while baffles contain the accumulated fat, oil and grease. The fat, oil and grease may be treated in a rendering plant.

Treatment Benefits

The removal of the fat reduces deposition in the receiving waste water pipelines and WWTPs and also reduces the pollution load.

Performance of Oil & grease trap

The size of the fat trap can vary depending on amount of fat produced and on how often the fat trap is maintained. Fat traps may be located inside or outside the building. If they are located inside the building they tend to be smaller and they require more frequent maintenance. Traps that are located outside the building will operate differently in winter and summer and are more prone to clogging during cold weather.

If the separated fat remains in the fat trap for a long period it degrades and consequently its usability decreases and odour problems may occur during storage and processing, which can incur subsequent increased treatment costs. Automatic and continuous removal of the fats, using a scraper, can minimise these problems

Economics

The investment required is reportedly compensated by the savings in wastewater treatment costs and plant maintenance.

3.7.1.4 Primary Settling Tank & Clari-flocculator

PST can capture suspended solids in wastewater by settling the solids with or without addition of chemicals. Removal of suspended solids reduces the pollution load in term of BOD and COD considerably. The sludge produced from the primary settling tank can be digested in anaerobic sludge digester for generation of biogas. Clari-flocculator consists of settling a flocculation zones in the same tank and the pollution load reduction are similar to primary settling tank

Treatment Benefits

Reduction of suspended solids reduces the pollution load to the subsequent biological treatment units thereby reducing the energy demand.

Performance of PST & Clariflocculator

The performance of PST and Clariflocculator varies depending addition of chemical or not. Without chemical addition, suspended solids removal ranges from 50-65% and chemical addition increases it to 70-80%. Due to the suspended solids, maximum BOD and COD removal of 35 and 50%, respectively, in PST/Clariflocculator.

Economics

Investment requirements are very less and compensated by the performance of treatment system.

3.7.2 Secondary Biological Treatments**3.7.2.1 Anaerobic digester**

Recent advances in anaerobic digestion technologies have made it possible to treat an increasing diversity of by-products and waste waters. Not only can slaughterhouse waste water under go anaerobic treatment, but manure, slaughterhouse waste, including blood, fat, and the contents of stomachs and viscera and residues can also be treated using anaerobic digester.

The co-digestion of manure and slaughterhouse waste is sometimes undertaken with industrial organic wastes.

Treatment Benefits

CH₄ can be recovered and used in energy production, to replace fossil fuels and thereby to reduce CO₂ emissions. Most of the nutrients remain in the treated material, which can be recovered/utilised for agricultural purposes.

Economics

Payback period for anaerobic digester plants have been reported as 5 - 6 years. The cost of disposal is saved.

3.7.2.2 Upflow Anaerobic Sludge Blanket (UASB)

In the upflow anaerobic sludge – blanket process, the waste to be treated is introduced in the bottom of the reactor. The wastewater flows upward through a sludge blanket composed of biologically formed granules or particles. Treatment occurs as the wastewater comes in contact with the granules. The gases produced under anaerobic conditions (principally methane and carbon di oxide) cause internal circulation, which helps in the formation and

maintenance of biological granules. The gas also causes the particles with the attached gas rise to the top of the reactor.

Performance of UASB reactor

It is reported that this type of reactor was suitable for anaerobic treatment of slaughterhouse wastewater and demonstrated a high COD removal of between 90.2 and 93.4% at organic loading rates between 2.49 and 20.82 g COD l⁻¹ day⁻¹. At an HRT of 12 hour, the reactor achieved a methane yield of 0.345 l (STP) per gram of COD removed.

3.7.2.3 Packed Bed Reactor

Treating wastewater from slaughterhouses or rendering plants through fixed bed reactors supporting anaerobic micro-organisms on plastic rings or balls or on sintered glass, can act as a technique to reduce the COD in waste water, prior to aerobic treatment. One particular technique operates in either a down-flow or up-flow operation, incorporating recirculation. However, the technique is unable to reduce either the COD or nitrogen content sufficiently for it to be more than just a partial treatment. It is reported to be capable of removing 73–76 % of COD in a rendering plant if 2 reactors are used, one operating in down-flow mode and the other in up-flow mode

Treatment Benefit

Anaerobic packed bed reactors (APBR) *etc.*, are sophisticated systems developed for accelerating the treatment and reducing area requirement. APBR are high organic loading, relatively small reactor volume and operational simplicity. They are stable under stressed operating conditions like shock loads, very low hydraulic retention time or low temperature and intermittent operation

Performance of the packed bed reactor

It is reported that, the slaughterhouse effluent responded well to anaerobic treatment in an upflow APBR with more than 80% COD removal efficiency. For OLR of 4-5 kg of COD/m³/day and HRT of 24 hours, 87-88% COD removal was achieved. When the OLR was increased to 5-6 kg of COD/m³/day, and at a reduced HRT of 18 hours, 82-85% efficiency was observed. When the applied OLR was in the range of 7-8 kg of COD/m³/day, at 24 hours HRT, the reactor showed signs of upset, but an efficiency of 82% in COD removal was still achieved.

3.7.2.4 Activated Sludge Process (ASP)

The aerobic digestion process using activated sludge involves production of an activated mass of micro-organisms, capable of stabilizing a waste aerobically in an aerated tank. During respiration, bacterial cells react with oxygen to produce CO₂, water and energy.

Treatment Benefit

Aerobic digestion is an effective technique for slaughterhouse waste water treatment. It removes principal inorganic nutrients such as nitrogen, phosphorus and sulphur as well as minor nutrients such as copper and zinc. In case of nitrogen it oxidises ammonia nitrogen to

nitrate nitrogen, thereby dealing with the oxygen demand. Further de-nitrification to nitrogen gas, under anoxic conditions is, however, required to remove the nitrogen.

3.7.3 Tertiary Treatment

3.7.3.1 Pressure Sand Filter (PSF)

In pressure sand filter raw water flows down wards through the filter bed and as the suspended matter- which has usually been treated by addition of a coagulant like alum- is retained on the sand surface and between the sand grains immediately below the surface. There is steady rise in the loss of head as the filtration process continues and the flow reduces once the pressure drop across the filter is excessive. The cleaning of the filter is effected by flow reversal. To assist in cleaning the bed, the backwash operation is often preceded by air agitation through the under drain system. The process of air scouring agitates the sand with a scrubbing action, which loosens the intercepted particles.

Treatment Benefit

- Turbid water may be treated
- Land required is less compared to slow sand filter
- Operation is continuous.

3.8 TREATMENT ADOPTED FOR SLAUGHTER HOUSES BASED ON THE SURVEY

The wastewater treatment scheme varies depending on the size, capacity and land available for effluent treatment plant. Based on the data collected through State Pollution control boards (SPCB) and Municipal Administration and visit by CLRI scientists, it is observed that different

treatment processes are adopted in India for treatment of wastewater from slaughter houses which are given in Figures 10 A- F.

Treatment scheme - I

In most of the small towns, the slaughter house are operated and maintained by municipality where animals are slaughtered only for domestic consumption of meat. They operate slaughter house by manual cutting of small animal in early mornings (only few hours). The amount of waste generated is minimal as most of the components of the small animals are consumed. Only floor wash water, partially digested food and dung from stomach is discharged as waste. These units generally do not have any treatment unit except settling tank. The supernatant after settling is conveyed to sewer line. The settled solids are removed only weekly basis and disposed along with municipal solid waste. This scheme was observed in Erode, Vaniyambadi, Ambur, Dindugul, Kolkata, Nagpur etc.

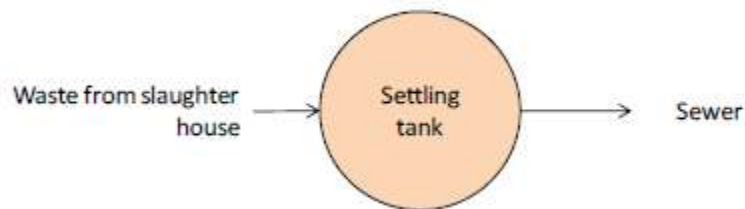

Figure 10A Treatment scheme - I

Treatment scheme - II

Most of the medium towns and corporations have organized slaughter house for small and large animals separately. These units also operate during morning hours and use manual cutting and lifting arrangements for the large animals. The units recently constructed with financial support of central/state governments have established effluent treatment plant which includes screen, equalization tank, and single stage biological treatment system. The treated wastewater is disposed in to sewer/on land. This is scheme was observed in Coimbatore, Kanpur, Chandigarh, Mumbai etc.

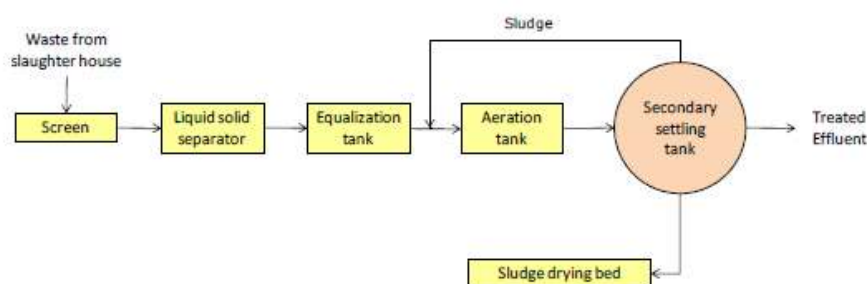

Figure 10B Treatment scheme - II

Treatment scheme - III

This treatment scheme is also adopted in medium towns and corporations where slaughter houses have been upgraded with the financial support of central and state government. In this scheme the energy requirement for effluent treatment is considerably reduced as

anaerobic reactor reduces the organic load to the extent of 50 -70 % to the subsequent aerobic biological treatment process. Anaerobic treatment requires very less operation and maintenance. This scheme is adopted in corporations like Madurai and Hyderabad.

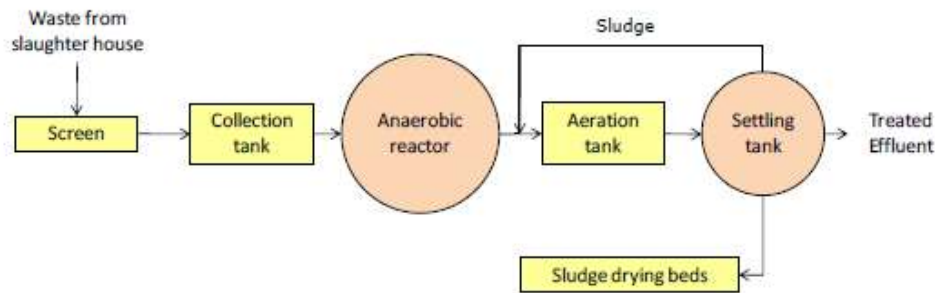

Figure 10C Treatment scheme - III

Treatment scheme - IV

This treatment is adopted in commercial slaughter houses where large animals are slaughtered in thousands per day. As the wastewater contains considered amount of organic load and volume, two stage anaerobic treatments followed by aerobic treatment is adopted to reduce the energy consumption and also to meet stringent environmental regulations. The biogas produced from the biological treatment along with biogas produced from solid waste bio-methanation plant is used as fuel. Thereby, reducing energy demand and also cost savings. This treatment scheme is adopted in commercial slaughter house at Hyderabad.

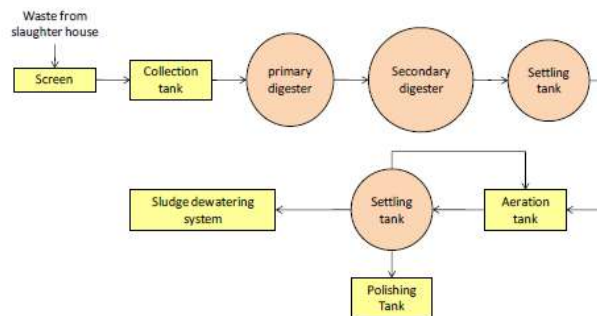

Figure 10D Treatment scheme - IV

Treatment scheme - V

This treatment scheme is adopted in commercial mechanized slaughter houses where large animals are slaughtered in thousands per day where the quantity of wastewater to be treated is considerable with high amount of organic load. Some of the units segregate high BOD waste streams and low BOD streams. High BOD is subjected to UASB reactor to reduce the major organic load without spending energy. The treated effluent from UASB is along with low BOD stream is treated in subsequent aerobic biological treatment for further reduction of organic load to meet the regulatory requirements. In some units the composite effluent is subjected to anaerobic treatment in UASB reactor followed by aerobic biological treatment. This scheme is adopted in Zaheerabad (Unnao).

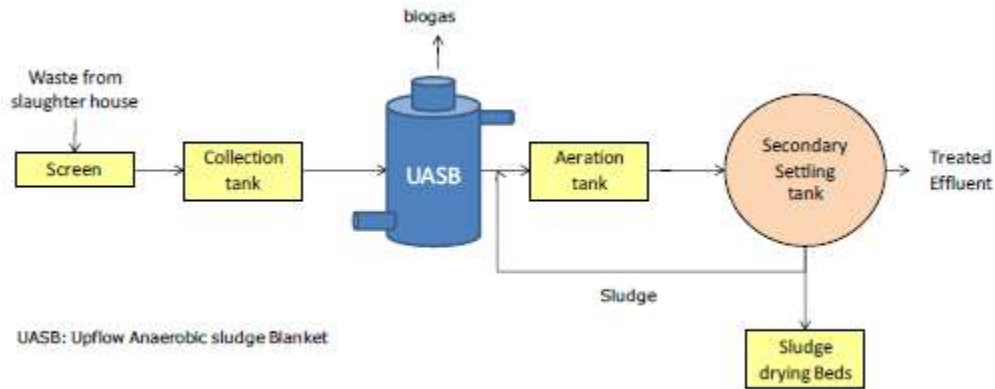

Figure 10E Treatment scheme - V

Treatment scheme - VI

This treatment scheme is adopted in recently upgraded treatment plant units in commercial mechanized export oriented slaughter houses where large animals are slaughtered in thousands per day. In this scheme DAF system is introduced to reduce the solid loads to the subsequent biological treatment units. The dissolved organics are reduced by UASB and aerobic biological treatment units. In this scheme, the operational cost is considerably reduced. This scheme is adopted in New Delhi and Zaheerabad (Unnao).

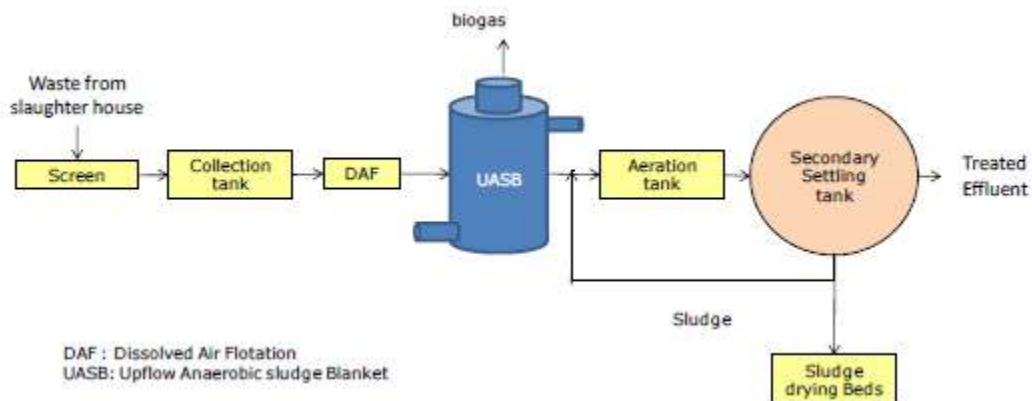

Figure 10F Treatment scheme- VI

3.9 COMPLIANCE WITH STANDARDS

The slaughter houses meant for domestic consumption of meat under the control of local bodies, municipalities and corporations are being operated in existing locations which lacks infrastructure facilities to meet the requirements of the discharge standards for effluent. However, some of the modern slaughter houses upgraded under the financial assistance of central and state governments have improved the infrastructure facilities including effluent treatment plants. These units mostly outsource the operation of effluent treatment plant to outside agencies as they do not have enough understanding and technical manpower to operate and maintain the effluent treatment plant. Many of the units do not have consent and their compliance with discharge standards is very poor. In some locations, modern slaughter houses with good infrastructure facilities are not being utilised due to non-cooperation of users in the existing locations.

However, some of modern slaughter houses under control of corporations are utilizing the infrastructure facilities for producing meat for local consumption as well as export purposes. These units have obtained consent and approval from the regulatory authorities for production of meat for export purpose, and these units also meet the discharge standards. These export oriented units are comparatively better in terms of compliance with the discharge standards compared with units used for production of meat for domestic consumption alone.

Commercial and export oriented units operating in various parts of the country have established mechanized slaughter house with adequate infrastructure facilities and have also obtained approval from regulatory authorities. These units have established effluent treatment plant as per the regulatory requirements. The compliance with respect to effluent discharge standards varies from plant to plant.

In states like Punjab, discharge of treated effluent is not permitted outside the premises of the slaughter house. The treated effluent should be disposed on land and used for irrigation. In some units, the treated effluent is used for landscaping and irrigation for developing green belts in and around the industry. In such plants, the compliance level is high.

4.0 IN-DEPTH STUDIES IN SLAUGHTER HOUSES

4.1 BASIC INFORMATION ON UNITS SELECTED FOR THE IN-DEPTH STUDIES

As per the requirements of the scope of the work, the detailed in-depth studies were carried out in 12 Nos of slaughter houses all over India. Twelve slaughter houses have been selected for in-depth study based on the scale of operation, geographical location, type of slaughtering, different treatment scheme adopted etc. For detailed in-depth study, a questionnaire was prepared and the information was collected from the slaughter houses.

The questionnaire prepared for the in-depth studies included the following details:

1. Details of the slaughter house which consist of location, type of animal slaughter, scale of operation, designed capacity, quantity of animals slaughtered, details of manpower, water consumption details, source of water consumption etc.,
2. Waste management aspect consists of liquid and solid waste generation, treatment system adopted, size of treatment units, capacity of mechanical equipment, mode of disposal etc.,
3. Details of characteristics of inlet and out of the ETP, performance of the effluent treatment plant.

Based on the data collected and field visit by CLRI scientist, the consolidated information of 12 slaughter house is given in Tables 8A & 8B.

During the visit, samples were collected from different stage of the unit in the ETP. Based on the sample analysis result performance of each treatment units, overall performance of the ETP have been estimated for all the twelve slaughter houses, and it is given in Table 9.

Based on the in-depth study data collection by questionnaire, field visit and sample analysis, basic details, processing capacity, liquid and solid waste generation, treatment scheme with sizes of units, performance of the treatment system, capital and operating cost of treatment system for all the individual twelve slaughter house considered for in-depth study are given in this chapter.

Table 8A Consolidated statistics of slaughter houses based on in-depth Studies

S.No	Name of the Slaughter house	Region/ Location	Owned by	Scale of operation	Type of Slaughtering	Animals (Small /Large)	Market	Treatment units
1	Unit I	North	Corporation, O&M Private	Large	Mechanized	Small & Large	Local & Export	DAF+UASB+ ASP
2	Unit II	North	Private	Large	Semi-Mechanized	Small & Large	Export	UASB+ASP+ PSF+ACF
3	Unit III	North	Private	Large	Semi-Mechanized	Small & Large	Local & Export	DAF+TS+ASP+A CF
4	Unit IV	North	Corporation	Large	Semi-Mechanized	Small & Large	Local	ASP
5	Unit V	North	Private	Large	Mechanized	Large	Export	UASB+ASP+TT
6	Unit VI	East	Corporation	Large	Semi-Mechanized	Small & Large	Local & Export	ASP+PSF
7	Unit VII	South	Corporation O&M Private	Large	Mechanized	Small & Large	Local & Export	UASB+ASP
8	Unit VIII	South	Private	Large	Mechanized	Small & Large	Local & Export	AD+ ASP
9	Unit IX	South	Corporation	Medium	Manual	Large	Local	ASP
10	Unit X	South	Corporation	Medium	Manual	Small	Local	ACT+ASP+PSF+A CF
11	Unit XI	South	Corporation	Medium	Manual	Small	Local	ASP
12	Unit XII	South	Private	Large	Mechanized	Small & Large	Export	DAF+UAS+ASP

Table 8B Consolidated statistics of slaughter houses based on in-depth Studies

S. No.	Slaughter House	Area, Acre	Animals-L per day	Animals-S per day	Frozen Meat Unit	Effluent treatment scheme	Solid waste, TPD	Rendering Plant	SWM
1	Unit I	2.09	1500	13500	Y	DAF, ET, UASB, ASP, Chlorination	15-25	Y	Landfill site
2	Unit II	20.26	800	500	Y	ET-2, UASB, CF, ASP, ASP, CF, DMF, AC	4 to 8	Y	Composting
3	Unit III	54	1500	2000	Y	ET, DAF, TS, ASP, ASP, SF, AC	6	Y	
4	Unit IV	3.69		230+60	N	ET, ASP, ASP	0.4	N	Biometahnation
5	Unit V	4	600		Y	ET-2, UASB-2, ASP, ASP, ASP, Disinfection, PSF, AC	6	N	Composting
6	Unit VI		800	10000	N	DAF, ET, ASP, ASP, PSF	15 to 20	N	Landfill site
7	Unit VII	70.34	300	3000	N	ET, UASB, ASP	10 to 20	N	Landfill site
8	Unit VIII		1800	3000	Y	ET, UASB, ASP, Polishing Pond, PSF, ACF	8	Y	Biometahnation
9	Unit IX	0.2	160		N	OT, ASP, SF	2.5	N	Composting
10	Unit X			1000	N	AnCT, ASP, PSF, AC	0.25	N	Landfill site
11	Unit XI			1000	N	ASP, PSF	0.2 to 0.8	N	Landfill site
12	Unit XII	121	3200	1500	Y	DAF, ET, UASB, ASP, ASP, Polishing Clarifier	12.8	Y	

Table 9 Performance of ETPs of slaughter houses based on in-depth Studies

S. No.	Slaughter House	ETP, KLD	Effluent, KLD	Raw effluent quality				Treated effluent quality			
				pH	BOD	COD	SS	pH	BOD	COD	SS
1	Unit I	1750	700 to 950	7.2	4400	5500	5400	8.3	23	246	124
2	Unit II	600	300					7.2	40	230	35
3	Unit III	600	400 to 600	7.2	3700	3900	2200	7.7	25	90	39
4	Unit IV	30	15	6.8	1760	2950	820	8.0	26	175	70
5	Unit V	1250	700					7.2	25	240	30
6	Unit VI	1200	1000	7.8	2480	2860	1850	7.2	24	230	50
7	Unit VII	600	600	7.4	4250	5600	3420	7.6	50	240	140
8	Unit VIII	1700	1570	7.1	3760	5180	3690	7.2	22	230	45
9	Unit IX	10	10	7.2	1730	2460	1200	7.8	20	180	30
10	Unit X	25	20	7.5	1600	2400	1200	7.2	30	240	75
11	Unit XI	10	2 to 10	7.5	1650	1960	1200	7.2	25	192	45
12	Unit XII	100	75								

4.2 TREATMENT COST ANALYSIS BASED ON IN-DEPTH STUDIES

Slaughter house effluent is highly biodegradable and organic in nature. Based on the information collected from twelve slaughter houses, it is observed that the effluent can be very well treated by the available and practicable technologies.

The effluent treatment in slaughter houses followed two major treatment schemes i.e., i) primary treatment followed by anaerobic biological treatment using up-flow anaerobic sludge blanket (UASB) and aerobic biological treatment using activated sludge process (ASP), and ii) primary treatment followed by aerobic biological treatment using ASP.

The capital costs of effluent treatment plants have been estimated for all the twelve slaughter houses, based on the capacity of the effluent treatment plant, the capital costs of civil units (CPWD rates) and that of mechanical and electrical equipment and piping items of ETP (based on market rates) and same is given in Tables 10 & 11. Similarly, the operation cost of ETP i.e. energy cost, chemical cost, manpower and maintenance cost has also been estimated for all the slaughter houses considered for in-depth study. The annualized cost of capital investment considering 30 years for civil units and 10 years for equipment and same is also provided in the Tables 10 & 11. Based on annualized capital and operative costs for ETPs, the effluent treatment cost per cubic metre has been estimated.

From the Tables 10 and 11, it is observed that for treatment scheme consisting of primary treatment followed by anaerobic treatment using UASB and aerobic biological treatment using ASP the total cost of treatment varies from Rs.32 to Rs. 56 per m³ of effluent (2015). For the other scheme consisting of primary treatment followed by aerobic biological treatment using ASP, the total cost of treatment varies from Rs. 69 to Rs. 230 per m³ of effluent (2015). It is clear that the first scheme is economical and the energy generated could be used as heat or electrical energy in slaughter house itself.

It is also observed that out of 12 units, 6 units are operated by local bodies. For municipal slaughter houses, the ratio of treatment cost to the slaughtering fee collected varies widely from 19% to 227%. The ratio is less in case of large slaughter houses (19%) while it increases to 218% and 227% in small slaughter houses. Thus, the cost of treatment is more than the slaughtering fee especially for smaller slaughter houses where it is more than double the slaughter fee, whereas in large slaughter houses the treatment cost is affordable. Hence, the slaughter fee needs to be increased to match with the treatment cost.

Based on the techno-economic analysis, it is suggested that the slaughter houses may follow the treatment scheme consisting of primary, anaerobic biological treatment, aerobic biological treatment and tertiary treatment to meet the prescribed standards, both private and corporation/municipal slaughter houses.

If the slaughter house is located in municipal area and the area is connected to the sewer, which is connected to sewage treatment plant (STP), then slaughter house may be permitted to discharge its effluent into the sewer after providing prescribed level of treatment. In such cases also the slaughter houses will require the treatment scheme consisting of primary and secondary aerobic biological treatment.

Table 10 Treatment cost analysis for anaerobic followed by aerobic treatment system

S.No	Description	UASB (Anaerobic followed by Aerobic system)					
		DAF+ UASB+ASP	OGT+UASB +ASP	UASB (H) + PST+ASP	UASB (H) + PST+ASP	AD+UASB +ASP	UASB (H) + PST+ASP
1	Wastewater treatment capacity (m ³ /day)	1750	600	600	1250	1700	1751
2	Capital cost (Civil, Mech, Electrical and piping) in Lakhs	887.6	223.6	284.4	265.4	588.0	756.8
3	Annualized Capital cost* in Lakhs	144.9	36.5	46.4	43.3	96.0	123.5
4	Operation & Maintenance cost per m ³ of effluent	20	18	40	32	32	36
5	Annual Operation & Maintenance cost in Lakhs	126.0	32.4	72.0	120.0	163.2	226.9
6	Total Annualized capital and operational cost in Lakhs	270.8	68.9	118.4	163.3	259.1	350.4
7	Capital and operation cost per day (364 days/yr)	75240	19139	32897	45367	71991	97345
8	Capital and operation cost per m ³ of effluent	43	32	55	36	42	56
9	Slaughtering Fee / day		21000				
10	Percentage of treatment per m ³ of effluent in slaughtering fee (%)		91				

Table 11 Treatment cost analysis for aerobic treatment system

S.No	Description	ASP					
		ET+OGT+ASP	PST+ASP + PSF	ET+ASP(2)+ SST(2)+PSF	ACT+ASP + TS+ PSF	ET+DAF+TS+ ASP+SST+PSF +ACF	ASP +PSF
1	Wastewater treatment capacity (m ³ /day)	35	10	1200	25	600	10
2	Capital cost (Civil, Mech, Electrical and piping) in Lakhs	33.0	17.9	584.1	15.2	742.5	17.9
3	Annualized Capital cost* in Lakhs	5.3	2.9	95.3	2.4	121.1	2.9
4	Operation & Maintenance cost per m ³ of effluent	70	178	56	68	40	178
5	Annual Operation & Maintenance cost in Lakhs	8.8	5.3	201.6	6.1	86.4	5.3
6	Total Annualized capital and operational cost in Lakhs	14.2	8.2	296.9	8.6	207.5	8.2
7	Capital and operation cost per day (364 days/yr)	3946	2296	82482	2390	57663	2296
8	Capital and operation cost per m ³ of effluent	113	230	69	96	96	230
9	Slaughtering Fee /day	6900	1600	437500	1050		1050
10	Percentage of treatment per m ³ of effluent in slaughtering fee (%)	57	143	19	227		218

5.0 REVIEW OF EFFLUENT STANDARDS

5.1 BEST PRACTICABLE TECHNOLOGIES (BPT) FOR CONTROL OF WATER POLLUTION IN SLAUGHTER HOUSES

5.1.1 Large slaughter houses

Based on in-depth studies carried out with respect to pollution load generated in twelve slaughter houses located all over India, it was observed that for large scale slaughter houses, the treatment scheme shown in [Figure 11](#) will be more an appropriate treatment to meet the prescribed discharge standards. The treatment scheme consists of coarse & fine screen, Dissolved Air Flootation (DAF) for removal of suspended solids, followed by two stage biological treatment i.e. anaerobic and aerobic systems. DAF ensures at least 50% to 70% removal of the suspended solids and corresponding organic load. Anaerobic treatment using UASB is a proven technology for reduction of organic load from wastewater generated from slaughter houses. The remaining organic load can be further treated in extended aeration system to meet the BOD discharge standard of 30 mg/L. However, suspended solids concentration exceeds prescribed level of 50 mg/L occasionally due to escape of sludge from secondary settling tank which can be controlled by having additional tertiary treatment unit like sand filter.

This treatment scheme is suitable for large slaughter houses to meet the prescribed discharge standards. However, this scheme requires technical manpower to operate and maintain the effluent treatment plant. In the absence of suitable technical manpower in the slaughter houses, it can engage the services of environmental experts / consultants for operation and maintenance.

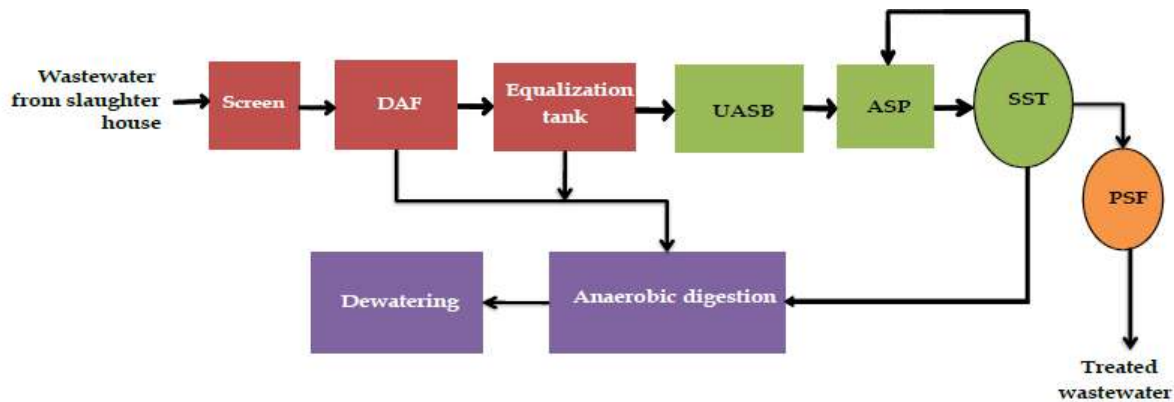
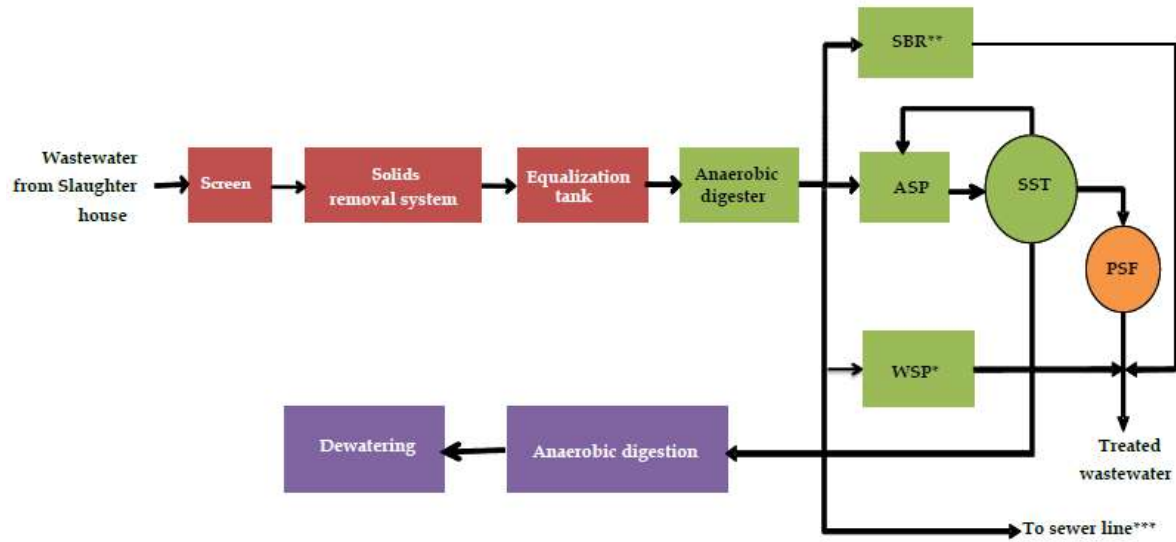

Figure 11 Schematic flow diagram of Best practicable technological option for wastewater treatment in large slaughter houses

5.1.2 Medium and Small slaughter houses

The in-depth studies reveal that most of small slaughter houses are operated and maintained by municipalities and corporations. For these slaughter houses, the treatment scheme shown in [Figure 12](#) can be adopted. This treatment scheme consists of screen, oil and grease trap, equalization tank, anaerobic digester, aerobic treatment and tertiary treatment. Primary treatment ensures removal of solids and oil & grease. In the anaerobic digester, removals of suspended solids, BOD and COD in the range of 50-60%, 60-75% and 50-70%, respectively, can be achieved subject to proper operation. Remaining organic load can be treated by the subsequent aerobic biological treatment process. Tertiary treatment can be installed to control the solids

escaping from secondary settling tank and thus meets the proposed discharge standards. This treatment scheme is suitable for medium and small scale slaughter houses. This scheme also requires technical manpower to operate and maintain the effluent treatment plant.



*If sufficient land is available, **SBR can be adopted if land is not available,

***Partially treated effluent can be discharged to sewer if sewer is connected to a STP

Figure 12 Schematic flow diagram of Best Practicable technological option for wastewater treatment in Medium and small scale slaughter houses

5.2 REVISION OF EFFLUENT STANDARDS

5.2.1 Pre-revision standards for slaughter houses

The pre-revision standards for slaughterhouses that were notified under the Environment (Protection) Rules 1986 on 21.2.1991 which are is given in Table 12.

Table 12 Pre-revision standards for slaughter houses notified on 21.2.1991 under the Environment (Protection) Rules 1986

50.	*SLAUGHTER HOUSE, MEAT & SEA FOOD INDUSTRY	EFFLUENTS	Concentration in mg/l
	Category		
	A.Slaughter House		
	(a) Above 70 TLWK/day	BOD ¹ [3 days at 27°C]	100
		Suspended Solids	100
		Oil and Grease	10
	(b) 70 TLWK/day below	BOD ¹ [3 days at 27°C]	500
	B.Meat Processing		
	(a) Frozen Meat	BOD ¹ [3 days at 27°C]	30
		Suspended Solids	50
		Oil & Grease	10
	(b) Raw Meat from own Slaughter House.	BOD ¹ [3 days at 27°C]	30
		Suspended Solids	50
		Oil & Grease	10
	(c) Raw Meat from other sources		Disposal via Screen and Septic Tank.
	C.Sea Food Industry	BOD ¹ [3 days at 27°C]	30
		Suspended Solids	50
		Oil and Grease	10

Note : (i) TLWK – Tonnes of Live Weight Killed (ii) In case of disposal into municipal sewer where sewage is treated the industries shall install screen and oil & grease separation units. (iii) The industries having slaughter house along with meat processing units will be considered in meat processing category as far as standards are concerned.

* The emission standards from Boiler House shall conform to the standards already prescribed under E(P) Act, 1986 vide notification No.G.S.R.742(E), dated 30.8.90.

¹ Substituted by Rule 2 of the Environment (Protection) Amendment Rules, 1996 notified by G.S.R.176(E), dated 2.4.1996 may be read as BOD (3 days at 27°C) wherever BOD 5 days 20°C occurred.

It is observed that the pre-revision standards for discharge of treated effluent have been fixed during 1991 when there were few large commercial slaughter houses in the country. These standards were fixed considering the treatment cost of wastewater generated from municipal slaughter houses where slaughtering of animals was meant for domestic consumption alone. During late 90s, the number of commercial large slaughter houses has increased considerably due to export potential of meat and meat products. Hence, there was a need for revision of standards

and accordingly CPCB took up this study considering the phase change in this sector and environmental pollution potential from this sector.

5.2.2 Revised standards for slaughter houses

Based on the CPCB advice, the Central Government has revised the above standards and notified the revised standards under the Environment (Protection) Rules 1986 on 28.10.2016, which are given in [Table 13](#).

Table 13 Revised standards for slaughter houses notified on 28.10.2016 under the Environment (Protection) Rules 1986

STANDARDS FOR DISCHARGE OF EFFLUENTS FROM SLAUGHTERHOUSES, MEAT PROCESSING UNITS AND SEA FOOD INDUSTRY			
S.No.	Industry	Parameter	Standard
1	2	3	4
50	A. Slaughterhouses or Meat Processing Units or Both*	Effluents	Maximum Concentration values are in mg/l except for pH
		pH	6.5 to 8.5
		Bio-chemical Oxygen Demand (BOD) [3 days at 27°C]	30
		Chemical Oxygen Demand (COD)	250
		Suspended Solids	50
		Oil and Grease	10
	B. Sea Food Industry*	Bio-chemical Oxygen Demand (BOD) [3 days at 27°C]	30
		Suspended Solids	50
		Oil and Grease	10
	<p>*The emission standards from Boiler House of Slaughterhouses or Meat Processing Units or both and Sea Food Industry shall conform to the standards prescribed vide notification No. G.S.R. 742 (E), dated 30.08.1990 as amended from time to time under the Environment (Protection) Act, 1986.</p> <p>Note:</p> <p>(i) For Slaughterhouses operating in local bodies/ municipalities, where the treated effluent is discharged into municipal sewers leading to full-fledged Sewage Treatment Plant, the BOD may be relaxed to 100mg/l.</p> <p>(ii) All Slaughterhouses/ meat processing units shall ensure safe and proper disposal of solid waste (Type I (Vegetable matter such as rumen, stomach and intestinal contents, dung, agriculture residues etc) and Type II (Animal matter such as inedible offal, tissues, meat trimmings, waste and condemned meat, bones etc.)) through suitable technology approved by SPCBs/PCCs. ”.</p>		

For removal of nitrogen and phosphorous, additional wastewater purification systems, which are based on either biological or physic-chemical processes are required. In the present standard, nitrogen and phosphorous are not included as high investment in the current scenario where proper treatment system for slaughter wastes as such doesn't exist. It can be incorporated in the future.

The effluent generated from the slaughter houses should be treated professionally and the discharge standards as given in the above Table 13 should be met with. For investment in this sector, public investors may be called for developing infrastructure in different forms like Public private partnership (PPP) or Build Own Operate and Transfer (BOOT).

5.3 SCHEDULES FOR MONITORING THE POLLUTION LEVEL

Treatment process monitoring and laboratory analysis of samples needs to be carried for efficient treatment of wastewater. The following parameters are to be monitored:

Equalization Tanks	pH, TSS, BOD, COD, Oil & Grease.
UASB/ PST outlet	TSS, BOD, COD
Aeration Tank	DO, MLSS, MLVSS, SVI, SV, Return Sludge Concentration (TSS).
Secondary Settling Tank Outlet	Suspended Solids, BOD, COD.
PSF / ACF Outlet	pH, BOD, Suspended Solids, COD, Oil & Grease.

All the above parameters are to be monitored on regular basis at least once in a week.

5.4 METHODS FOR TREATMENT AND DISPOSAL OF SOLID WASTES FROM SLAUGHTER HOUSE WASTES

Solids waste generated from slaughterhouses such as cow dung, intestines, solids from effluent treatment plant are disposed of along with municipal waste which attract flies, dogs and other vermin, leads to leachates problem, contamination of surface and ground water thus causing public nuisance and also accompanied by danger of disease spread. Segregated organic fractions of solids like slaughter houses should be treated in rendering plant and/or on their own site.

5.4.1 CLASSIFICATION OF SOLID WASTE

The solid waste of slaughter houses can be broadly classified into two categories i.e. vegetable matter and animal matter as given in Table 14 below. These waste streams must be segregated for proper treatment of waste.

Table 14: Classification of solid wastes

Category of waste	Constituents
Type I	Vegetable matter such as rumen, stomach and intestine contents, dung, agriculture residues etc.
Type II	Animal matter such as inedible offals, tissues, meat trimmings, waste and condemned bones, etc.

5.4.2 SOLID WASTE MANAGEMENT

Almost every by-product of slaughter house can be utilized. However, various circumstances, especially the scale of operation, do not always permit by-product recovery. In such instances, they form part of waste that needs to be treated properly before disposal. For the slaughter house wastes treatments, composting, bio-methanation and rendering systems are suggested. Selection of appropriate method depends on characteristics of waste and its quantity. Incineration should be the last preferred option.

5.4.2.1 Composting

Practically, all slaughterhouse waste can be used for composing. The agriculture residue and dung from the lairage, ruminal and intestinal contents, blood, meat cuttings, floor sweepings, hair, feathers, hide trimmings can be composted.

For preparation of compost stack, it is suggested that alternate layers of type I and type II waste should be built up to a height of 4-5 feet. The heap should be laid directly on the ground. It is advisable to put about 6 inch of course of coarse material, such as maize or millet stalks, banana stems, straw, grass, small twigs etc. underneath in order to achieve proper ventilation. In case type II waste contains large organs such as kidneys and lungs or other similar wastes, then they are minced or chopped to 2-3 inch pieces. It is advised to mix these pieces with the earth and evenly spread out in the centre of the heap where the temperature is high. Higher temperature

keeps rats, dogs and other vermin away. Water is not needed initially as the moisture from ruminal and intestinal contents is sufficient for start of bacterial activity.

To achieve optimum conditions for the bacteria, moisture and proper aeration must be maintained from start to finish. A gradual reduction in height will follow due to shrinkage of decomposing matter. At least two turnings are required for a uniform compost material. The first turning is advised after 2-3 weeks and the second after 3-4 weeks. The total time required is about 45 days. However, it can vary due to factors such as type of material, size of heap and ambient temperature, etc.

When a clean, neat and tidy heap is required, compost bunkers can be constructed. Bricks or cement wall may be used to build a wall, leaving open space between bricks. Brick walls are preferred over wood as the latter tends to rot unless properly preserved. The size of the bunkers depends on the raw materials required to be converted. Also it should facilitate easy turning of material and removal of finished compost.

5.4.2.2 Bio-methanation

A biomethanation plant can be constructed in two ways i) digester with separate gas holder ii) combined digester with gas holder. The gas is produced in one or more digesters and stored in a separate gas holder from where it is drawn as and when required. In the other method the digester and gas holder form a single unit. The gas is produced in the lower part of the structure while the upper tank serves as a gas reserve. While the second option is extremely simple and cheap in construction, it has a disadvantage that gas production is affected during recharge. On the other hand, with a separate gas holder, continuous supply of gas can be assured even when one or more digesters are being charged. It is therefore more practical for larger units to have separate gas holders.

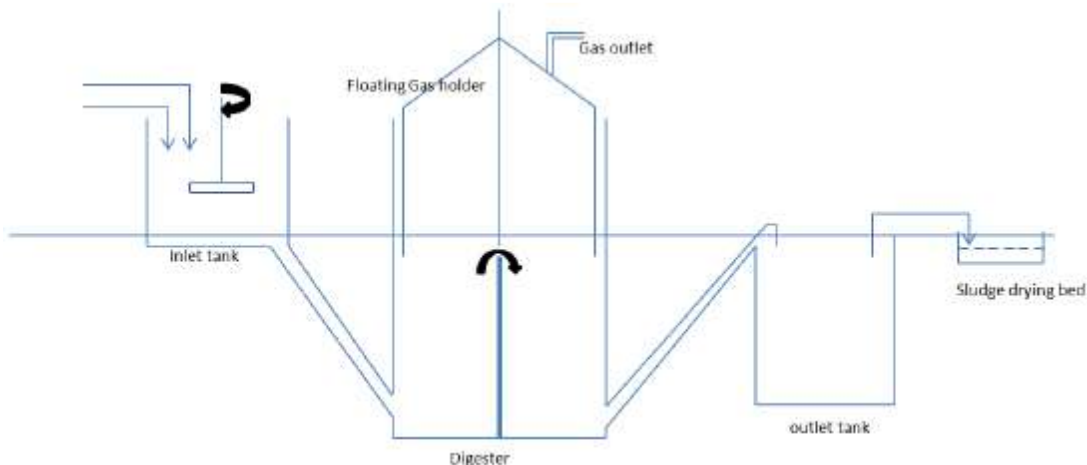

Figure 13 Schematic diagram of Conventional Biogas Plant

Conventional Biogas Plant has a floating drum type gas holder. An inverted drum with a diameter slightly less than that of cylindrical digester serves as gas holder. The plant delivers gas at uniform pressure and provided good seal against gas leakage. It is reliable and has proven performance for cattle dung processing. The plant feed on slaughter house wastes, such as rumen and paunch contents, dung etc. will also exhibit same performance when loading rate is

maintained about 0.5-0.6 kg volatile solids/m³/ day. The waste should be suitably diluted before feed. The plant can handle feed with solid content up to 8 percent.

The anaerobically digested sludge has higher nitrogen content than compost manure. The sludge should be dewatered by filtration bed or filter press. The dried sludge can be utilized as manure in agriculture/horticulture. The filtrate is recycled for preparation of feed slurry, which contains microorganism. The biogas can be used for boiler or power generation.

The success of biomethanation plant depends on several factors, such as the quality of raw material, temperature, ratio of water to solids, and also on the type of bacterial mass.

The economics of a typical biogas plant processing 1250 kg/day of waste is presented in [Table 15](#). It can be seen that the plant can save up to Rs. 65,000/- per year on account biogas and manure.

Table 15 Economics of a biogas plant

Particulars		Value
1	Waste processing	1250 kg/d
2	Capital cost	Rs. 6.5 lakh
3	Operation and maintenance cost	Rs. 3.0 lakh/year
4	Interest and depreciation at 10% interest , plant life 10 years	Rs. 0.9 lakh/year
5	Potential returns	
	Biogas generation	42.5 m ³ /day
	Equivalent power at 2 kwh/m ³	85 kwh/day
	Cost of power at Rs. 5/ kwh	Rs. 1.56 lakh/year
	Quantity of manure	164 kg/day
	Cost of manure at Rs. 5/ kg	Rs. 2.99 lakh/year
6	Savings(5-3-4)	Rs. 0.65 lakh/year*

Note: * Savings can be improved by direct utilization of biogas for heating purpose.

High Rate Biomethanation: The essential elements of a high rate biomethanation are complete mixing and uniform temperature with more or less uniform feeding of the substrate. Pre-thickening or dilution of the digester contents are optional features of high rate digesting system. The benefits of high rate biomethanation are – reduced digester volume requirement and increased process rate stability. In high rate biomethanation system, there is proper arrangement for operation control and safety measures.

Complete mixing of substrate in a high rate digester creates a homogenous environment throughout the digester. It also quickly brings the feed in contact with the microorganisms and evenly distributes toxic substances if any, present in the wastes. The entire digester is available for active decomposition, thereby increasing the solids retention time. Temperature is one of the most important factors. In cold climate digester heating is beneficial because it increase the rate of digestion and thereby biogas production. A schematic diagram of a typically high rate biomethanation plant is given in [Figure 14](#).

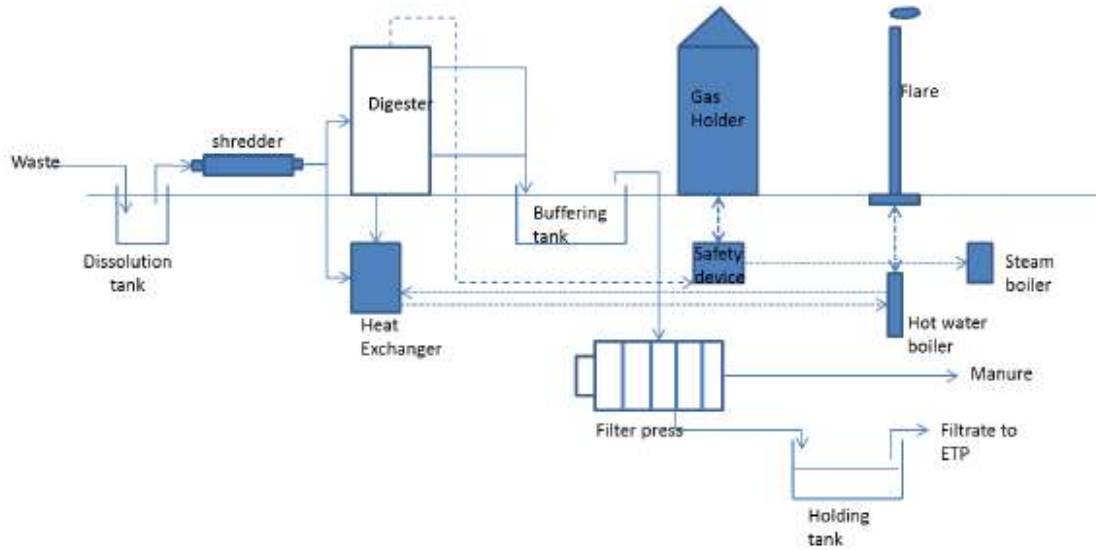

Figure 14 Schematic diagram of a typically high rate biomethanation plant

Wastes consisting of rumen and paunch contents, dung, agriculture residue, fat and blood are processed in the high rate plant. The solid wastes from different sections are collected in the dissolution tank. The dissolution tank is used to adjust the moisture and solid ratio and for mixing the waste thoroughly. The waste containing up to 12 % solids is passed through shredder, which reduces solid waste size to required level. Waste will be pumped into the digester. Hydraulic retention time is about 25 days. At organic loading rate up to $2.5\text{kg}/\text{m}^3/\text{day}$, the digester can give up to 55 % efficiency in terms of volatile solid destruction. In digester optimum temperature of about 36°C can be maintained with the help of heat exchanger. The digester will have all accessories such as temperature and pressure indicators, overflow, safety valve etc. Specific biogas production in high rate plant is about $0.8\text{ m}^3/\text{kg}$ of volatile solids destroyed, which is equivalent to $2.11\text{ kWh}/\text{m}^3$ of gas.

Economics of a typical high rate biomethanation plant catering to 60 tonnes/ day of waste is worked out in the [Table 16](#). The plant generates about 2600 m^3 biogas and 7 tonnes manure in a day which can give an income of Rs. 40 lakh per annum.

Table 16 Economics of high rate biomethanation plant

Particulars	Value	
1	Waste processing	60 tonnes/day
2	Capital cost	Rs. 15 crores
3	Operation and maintenance cost	Rs. 18 lakhs/year
4	Interest and depreciation at 10% interest, plant life 15 years	Rs. 160 lakhs /year
5	Potential returns	
	Biogas generation	$2600\text{ m}^3/\text{day}$
	Equivalent power at $2.11\text{ kwh}/\text{m}^3$	$5500\text{ kwh}/\text{day}$
	Cost of power at Rs. 5/ kwh	Rs. 100 lakhs/year
	Quantity of manure	$7000\text{ kg}/\text{day}$
	Cost of manure at Rs. 5/ kg	Rs. 128 lakhs/year
6	Savings(5-3-4)	Rs. 50 lakhs/year

5.4.2.3 Rendering

All animal matter i.e. type II wastes such as inedible offal, tissues, meat trimmings, waste and condemned meat and bones, etc. can be processed in rendering system. The main constituents of animal matter are fat, water and solids. The objective of rendering process is to physically separate the fat, the water and the solids. This is effected by heating and rupturing connective tissue of individual fat and muscle cells so that raw fat and other material bound within is freed. In rendering, fat recovered is used for industrial purposes such as manufacture of soap and greases. Fat recovered from fresh flesh and healthy eatable parts can be use for edible purposes also. Solid portion which is known as meat meal or bone meal is utilized for the manufacture of stock feed and fertilizers.

Rendering is carried out either in dry rendering or wet rendering plants. In both processes, large pieces such as heads, bones etc. are reduced in size by shredders or other machinery. Large soft offals are also cut to size before processing. Intestines, stomachs and similar soft materials contain manure and therefore they are opened and cleaned before feeding to rendering plant.

Wet rendering: the name wet rendering is applied where the raw material is processed with added water or condensate derived from steam. The wet rendering tank is usually a vertical, cylindrical boiler, having a cone shaped bottom with a gate valve outlet.

At the top of the tank there is a manhole through which raw material is loaded, and also a valve thru which obnoxious gases escape without reducing the pressure. Several draw off cocks on the side of the tank at different levels; enable the fat and water to be removed. After the raw material is loaded, the manhole is tightly closed and steam is injected into the mass from the bottom. The steam pressure used will vary with the material. The higher the pressure, the quicker the disintegration. For this reason, large plants often render offal at a pressure of 4 kg/cm². However, high pressure may reduce the quality of material, especially of the fat. For this reason, a pressure of 3 kg/cm² is usually maintained in the tank.

The time required to disintegrate the tissue and free all fat varies from four to six hours, depending on the character of the offal. After cooking is completed, the contents of the tank are allowed to settle for about two hours. After settling, a clean division is formed between the digested material, water and fat. The fat, having the lowest specific gravity, will be on the top, the sludge and solids having the high specific gravity will be at the bottom. The center will be occupied by water. Gradually the pressure is reduced to that of the atmosphere, and then water and fat are ready to be drawn off through the side cocks. If the fat level is below a cock, the level can be raised as required by addition of water. After the fat and tank water have been removed, the gate valve is opened and the digested mass of meat and bones is taken out. At this stage the mass may contain up to 55 % moisture and about 15 % fat which can be dried in the dryer to obtain meat meal or bone and meat meal.

For large operation, integrated continuous rendering plants are used. An integrated rendering plant consists of pre-breaker, metal detector, fat separator, dryer and hammer mill. Total yield of bone and meat meal by wet rendering system is about 30 percent of raw material weight and tallow about 10 percent. A schematic diagram of the integrated wet rendering plant is given in Figure 15.

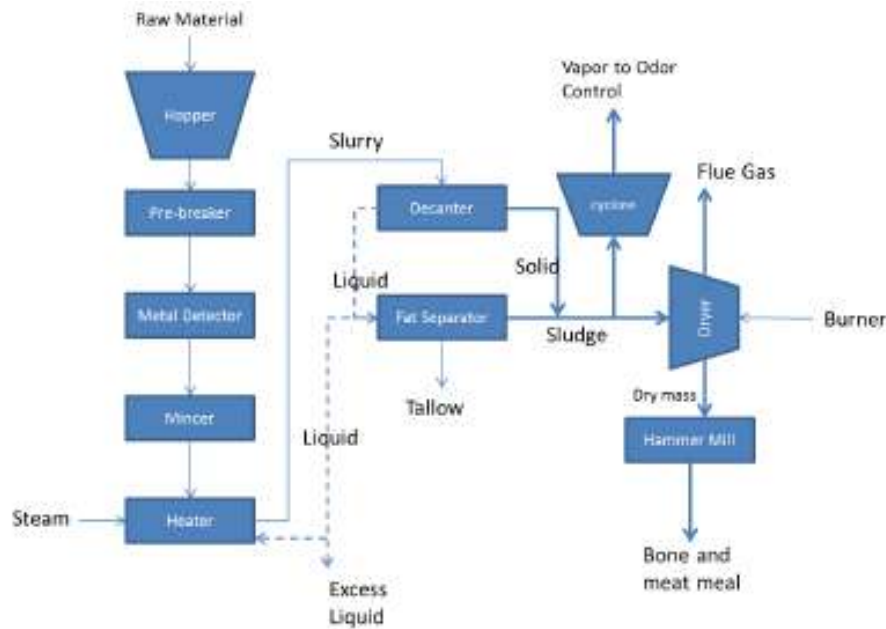

Figure 15 Schematic diagram of the integrated wet rendering plant

Dry Rendering: In this process, all the unwanted moisture is eliminated from type II wastes without loss of any nutrient by using specially designed cooker. The dry rendering cooker is a horizontal steam jacket equipped with a set of agitators, which keep the material in continuous motion. The steam is applied to the jacket only and not to the material to be processed, as in wet rendering.

The material remains in the cookers for about 4 to 5 hours in most plants. Steam pressure in the cooker jackets usually ranges from 3 to 4 kg/cm². The dry heat transmitted from the steam jacket to the raw material converts the moisture present in material into steam, which gradually builds up the internal pressure of cooker. This pressure, combined with agitation, disintegrates the material and breaks down the fat cell. Dry rendering therefore works on steam pressure developed from the moisture contained in the raw material itself, and not as in wet rendering, from the pressure created by injected steam.

In dry rendering, the fat is released from the fat cells but is still dispersed throughout the material. The fat in the solids may be removed by either a hydraulic press or by using a centrifugal turbine fat extractor.

As seen from the above, the whole process, i.e., sterilization, digestion, and drying, take place in cooker only. Therefore, there is no loss of nutrient. The dry rendering process allows approximately 20 percent higher yield than the wet rendering, as the water containing water-soluble extractives and proteinous suspended matter is not discarded.

The dry rendering plants comprise of units such as metal detector, pre-breaker, cooker, fat extractor and hammer mill. A schematic diagram of a typical dry rendering plant is shown in [Figure 16](#).

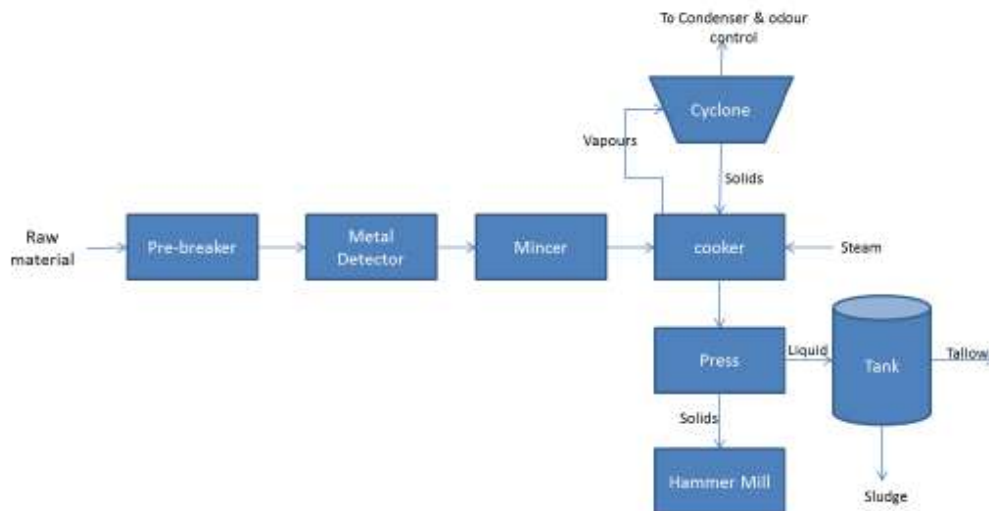

Figure 16 Schematic diagram of typical dry rendering plant

Economics of dry rendering plant installed in a mechanized slaughter house has been worked out and presented in [Table 17](#). On an average a typical plant renders 65 tonne/day of animal matters to produce 20.25 tonnes bone & meat meal and 8 tonnes tallow in a day.

Table 17 Economics of dry rendering plant

Particulars		Value
1	Waste processing	65 tonnes/day
2	Capital cost	Rs. 14.5 crores
3	Operation and maintenance cost	Rs. 72 lakhs/year
4	Interest and depreciation at 10% interest, plant life 10 years	Rs. 245 lakhs/ year
5	Returns	
	Bone and meat meal production	20.25 tonnes/day
	Cost of bone & meat meal @ Rs.12/kg	Rs. 887 lakhs/year
	Tallow production	8000 kg/day
	Cost of tallow @ Rs. 22/kg	Rs. 64.2 lakhs/year
6	Savings(5-3-4)	Rs. 634 lakhs/year

5.4.2.4 Incineration

Incineration can be used for treatment of almost all types of wastes. In incineration, the waste is burnt at temperatures between 850 °C and 1100 °C in specially designed combustion chambers. An auxiliary fuel is required to start ignition and sustenance of combustion of wastes. The wastes are converted to gaseous constituents and non-combustible residue. The gases are released to atmosphere and the residue is disposed to landfill. Incineration does not require long residence as in other methods. Proper temperature control, mixing and turbulence are necessary for effective combustion. It requires skilled manpower for operation. Capital cost and recurring expenses of incinerator are high. By using heat recovery system, through use of energy the cost of operation can be reduced. Incineration technique is yet to be practised for treatment of slaughter house wastes in our country.

5.4.3 CONCLUSIONS AND RECOMMENDATIONS

Most of the slaughter houses in the country are very old and still in primitive condition. These units operate with inadequate basic amenities such as lairage, proper flooring, water supply etc. Further, many slaughter houses are much smaller and widely scattered. To equip such units for effective processing of waste is a challenge. On reviewing various methods and the constraints, the best practicable method for different categories of slaughter house are suggested in the following paragraphs.

Large slaughter house are mostly in cities and located in congested areas. They generate substantial quality of solid wastes, which have to be processed in environmentally acceptable manner. For the large slaughter houses, biomethanation of Type-I waste and rendering for Type-II waste are suggested. Biomethanation requires less space, which is advantageous for the slaughter houses with land constraints.

Biomethanation for Type-I waste and rendering for Type-II waste should also be considered for medium size slaughter houses with an alternative of composting.

In case of small slaughter houses, sophisticated and capital intensive technologies is unviable due to low volume of wastes and non-availability of other infrastructure facilities. For small slaughter houses, a more pragmatic approach would be to make use of natural process such as composting. This would be financially and technically viable and should be acceptable for the small slaughter houses.

The best practicable methods currently available for processing and disposal of different wastes for the slaughter houses are summarized in Table 18.

Table 18 Methods for processing, utilization and disposal of solid wastes from slaughterhouse

Type of Waste	Constituents of wastes	Category of Slaughter House	Methods
Type I	Vegetable matter such as rumen, stomach and intestinal contents, dung, agriculture residues etc.	Large	Biomethanation
		Medium	Biomethanation or Composting
		Small	Biomethanation or Composting
Type II	Animal matter such as inedible, offals, tissues, meat trimmings, waste and condemned meat, bones etc.	Large	Rendering
		Medium	Rendering or Composting with type I waste
		Small	Composting with type I waste or Burial*

*should be considered as provisional measures

All above methods facilitate recovery of secondary by-products such as manure, biogas, fat, bone and meat meal etc. while disposing the wastes in an environmentally sound matter. Adoption of

above methods for solid waste management will improve sanitation in and around slaughter houses and it is beneficial to the slaughter houses in long run due to returns on account of recovery and use or sale of the secondary by-products.

Composting facility requires no initial investment except land cost. Once the compost system comes into operation, it produces manure, which is good soil conditioner. Bio-methanation is well suited for the slaughter house waste to generate methane gas, which can be utilized for water heating, boiler or power generation and the manure of much greater fertilizing value than ordinary compost. Fat and bone and meat meal obtained from rendering of animal matter also have several commercial usage.

There is a need to upgrade old slaughter houses on modern lines for overall improvement in sanitation and hygiene and wholesome meat production. For modernization of existing slaughter houses, the Ministry of Agriculture, Government of India provides assistance to the states. Financial incentives are also provided by the Ministry of New and Renewable Energy for setting up of biogas plants and high rate bio-methanation plants under its programmes on energy recovery from urban and industrial wastes.

All slaughterhouses/ meat processing units shall ensure safe and proper disposal of solid waste {Type I (Vegetable matter such as rumen, stomach and intestinal contents, dung, agriculture residues etc) and Type II (Animal matter such as inedible offal, tissues, meat trimmings, waste and condemned meat, bones etc.)} through suitable technology approved by SPCBs/PCCs.

State wise Slaughter Houses in India
(as per information collected by CLRI)

S.No	State	No.of Slaughter Houses
1	Andhra Pradesh**	224
2	Arunachal Pradesh**	1
3	Assam	1
4	Bihar*	42
5	Chhattisgarh	26
6	Goa**	1
7	Gujarat	38
8	Haryana	37
9	Himachal Pradesh	37
10	Jammu and Kashmir*	2
11	Jharkhand**	1
12	Karnataka	86
13	Kerala**	47
14	Madhya Pradesh**	25
15	Maharashtra**	106
16	Manipur	-
17	Meghalaya**	4
18	Mizoram**	2
19	Nagaland	-
20	Orissa	65
21	Punjab**	43
22	Rajasthan**	8
23	Sikkim**	4
24	Tamil Nadu**	135
25	Tripura	0
26	Uttarakhand**	25
27	Uttar Pradesh**	179
28	West Bengal**	29
Union territory		
29	Andaman and Nicobar Islands**	1
30	Chandigarh	1
31	Delhi	1
32	Dadra and Nagar Haveli	1
33	Daman and Diu**	2
34	Lakshadweep	1
35	Puducherry	1
Total		1176

*List not provided to CLRI **as per information provided by SPCB directly

Slaughter houses-cum-meat processing plants and standalone slaughterhouses registered with APEDA for export of meat from India

S. No.	Name of the Exporter and Contact Person	Unit(s) registered by APEDA	Registration No.	Products permitted for export	Registration validity up to
1.	Cdr. Satish Subberwal Director M/s. Al-Kabeer Exports (P) Ltd. 53, Jolly Maker Chamber No. 2 Nariman Point, Mumbai-400021 Tel: 022-22023768 Fax: 022-22028475 E-Mail: alkabeermumbai@gmail.com	M/s Al-Kabeer Exports (P) Ltd. Village - Ruduram Patancheru Mandal Distt. Medak, Telangana State	APEDA/16	Buffalo/ Sheep and Goat meat	31.7.2018
2.	Mr. Afzal Latif President M/s. Allansons Private Limited. Allans Centre, 113/115, M.G. Road, Fort, Mumbai - 400001 Tel: 022-56569000, 22628000, 56569056 Fax 022-22641133, 22691133 E-Mail: alatif@allans.com ; aziz@allans.com	M/s. Frigorifico Allans Private Limited. P.O. Box -14, Paithan Road, Gevrai, Aurangabad-431002 Maharashtra (Plant - I)	APEDA/20 (Plant - I)	Buffalo/ Sheep and Goat meat	30/11/2016 Extension valid upto 31.3.2017
3.	Mr. Afzal Latif President M/s. Allansons Private Limited. Allans Centre, 113/115, M.G. Road, Fort, Mumbai - 400001 Tel: 022-56569000, 22628000, 56569056 Fax 022-22641133, 22691133 E-Mail: alatif@allans.com ; aziz@allans.com	M/s. Frigorifico Conserva Allans Private Limited. Survey No. 325, IDA, Algole Road, Zaheerabad-502 220, Distt. Medak, Telangana State	APEDA/21	Buffalo/ Sheep and Goat meat	29.12.2019
4.	Mr. Afzal Latif President M/s. Allansons Private Limited. Allans Centre, 113/115, M.G. Road, Fort, Mumbai - 400001 Tel : 022-56569000, 22628000, 56569056 Fax 022-22641133, 22691133 E-Mail: alatif@allans.com ; aziz@allans.com	M/s Frigorifico Allans Private Limited. Paithan Road, Gevrai Village Aurangabad-431002 Maharashtra State	APEDA/23 (Plant-II)	Buffalo meat	22.1.2020
5.	Mr. Sirajuddin Qureshi Managing Director M/s. Hind Agro Industries Ltd. Plot No A-1, Phase-1 Okhla Industrial Area New Delhi - 110020 Tel: 011-26372786 - 92 Fax : 011-26817941, 26817942 E-mail: info@hind.in ; sirajuddin@vsnl.com	M/s Hind Agro Industries Ltd., CDF Complex, Anupshahr Road, Aligarh, U.P	APEDA/24	Buffalo /Sheep and Goat Meat	14/6/2017
6.	Mr. Afzal Latif President M/s. Allansons Private Limited. Allans Centre, 113/115, M.G. Road, Fort, Mumbai - 400001 Tel: 022-56569000, 22628000, 56569056 Fax 022-22641133, 22691133 E-Mail: alatif@allans.com ; aziz@allans.com	M/s Indagro Foods Private Limited Plot No B-1-5, U.P.S.I.D.C., Industrial Area, Site-2, Unnao (U.P.)	APEDA/ 36	Buffalo meat/ sheep and goat meat	6.8.2018
7.	Mr. Mujeeb Malik Joint Managing Director M/s. ALM Industries Ltd.	M/s. ALM Industries Ltd., Kh.No.460, Village Harora, Ahmadi,	APEDA/ 38	Buffalo meat	30.12.2017

	43, Qutab Market, Near Thana Qutab Shar, Ambala Road, Saharanpur - 247001, (U.P.) Tel: + 91 132 3250314-15 / 3298120 Fax: + 91 132 2785046 E-mail: modalm786@gmail.com ; slm787@hotmail.com ; musalik131@rediffmail.com	Dehradun Rd Saharanpur (U.P.)			
8.	Mr. V.I. Saleem CEO M/s Amroon Foods Pvt. Ltd. Plot No. 20/1, Site IV Industrial Area Sahibabad, Ghaziabad (U.P.) M/s Fair Exports (India) Pvt. Ltd. 501, Madhava, Bandra Kurla Complex, Bandra East, Mumbai Tel: 0120 2771126/27/2773734 Fax: : 0120-2771125 E-mail: amroonfoods@amroonfoods.net ; fairat@fairexports.net ;	M/s. Amroon Foods Pvt. Ltd. 1310/6,7,9,11 Kursi-Agrase Road, Kursi, Distt. Barabanki (U.P.)	APEDA/ 42	Buffalo/ Sheep and goat meat	31.12.2017
9.	Mr. Sunny Abbott Director M/s. Abbott Cold Storages Pvt. Ltd. 80 M.M. Janpath New Delhi-110001 Tel: 011-23329491,23328474 Fax : 011-23357554 E-mail: mkarabot@gmail.com	M/s. Abbott Cold Storages Pvt. Ltd. Vill. Sangauli Hadbast No. 196 The. Derabassi Distt. Mohali , Punjab	APEDA/ 47	Buffalo meat	26.7.2018
10.	Mr. Mohammad Atif Jt. Managing Director M/s. Al-Nafees Frozen Food Exports Pvt. Ltd. 6, Central Lane, Bangali Market, New Delhi - 110001 Tel: 011-23318801, 8804, 8806, 8808 Fax 011-23318815, 19 E-mail : alnafees@ndf.vnl.net.in ; alnafees_mohdatif@yahoo.in	M/s Al Nafees Proteins Pvt. Ltd. Village Satakpuri, Tehsil Punhana, Distt. Meerut (Nuh), Haryana	APEDA/ 48	Sheep and goat meat	30/9/2017
11.	Hazi Mr. Shahid Akhlaq CEO M/s Al - Saqib Exports (P) Ltd., 2035, Qasim Jan Street, New Delhi - 110006 Tel: +91-11-23795050 Fax: +91-11-23015677 E-mail: info@alsaqibexports.com ; export@alsaqibexports.com ; marketing@alsaqib.com	M/s Al Saqib Exports Pvt. Ltd. 11 KM Milestone, Hapur Road, Village Alipur Jajwana, Distt Meerut, U.P.	APEDA/ 49	Buffalo meat	6.10.2018
12.	Mr. Rashid Kadimi President M/s All India Meat and Livestock Exporters Association (AIMLEA) 3 rd Floor, Sidhwa House Sidhwa Estate Nr. Colaba Fire Brigade Colaba, Mumbai 400 005 Tel: 022 22020836 Fax: 022 22020835 E-mail: aimlea@india.com ; rkadimi@alliana.com	M/s Deonar Abattoir Deonar Govandi, Mumbai	APEDA/ 50	Sheep meat	20.7.2017
13.	Mr. Afzal Latif President M/s. Allansons Private Limited, Allana Centre, 113/115, M.G. Road, Fort, Mumbai - 400001 Tel : 022-56569000, 22628000, Fax 022-22641133, 22691133	M/s. Medina Frozen Food Exports (P) Ltd Mundakhera Road, Khurja Bulandshahr, UP	APEDA/54	Buffalo meat	31.12.2017

	E-Mail: alatif@allana.com ; anzin@allana.com ;				
14.	Mr. Mohd. Kamil Qureshi Managing Director M/s. M.K. Overseas Pvt. Ltd. 14, Fire Brigade Lane, Near World Trade Centre, Connaught Place New Delhi - 110001 Tel: 011-23522165, 23635400, Fax: 23674988 E-Mail: mkgroupofindustry@gmail.com	M/s M.K. Overseas (P) Ltd. 7 th KM, Stone, Sangouli, Derabassi Link Road, Vill. Sangouli Derabassi, Patiala, Punjab	APEDA/55	Buffalo/ Sheep and goat meat	31.3.2017
15.	Mr. Sunil Sud Director M/s Al Noor Exports C-4/10, 2 nd Floor, Safdarjung Development Area New Delhi 110016 Tel:011-26963473 Fax :011-26854934 E-mail: sunil@alnoorexports.com ; alno@alnoorexports.com	M/s Al Noor Exports Village: Sharnagar 9 th Km Jantash Road Muzaffarnagar, Uttar Pradesh	APEDA/56	Buffalo meat	31.12.2018
16.	Mr. Gulzar Ahmed Qureshi Director M/s HMA Food Exports Pvt. Ltd. 2/220, 2 nd Floor, Glory Plaza OPP. Sur-Sadam, M.G. Road Agra 282002, U.P. Ph no.:- 0562-4000188 Fax no.:- 0562-2523230 E mail: hmafiquan@rediffmail.com ; info@hmasexport.com ; tanqaswar@hmasagro.com ; gulzeb@hmagroup.co	M/s H.M.A. Food Exports Pvt. Ltd. Plot NO.293, 295,297 Village Kubarpur Tehsil Etmadpur Distn. Agra 282006	APEDA/ 61	Buffalo meat	25.12.2018
17.	Mohd. Tauseef Director M/s Al-Hamad Agro Food Products Pvt. Ltd. Sarai Miyan, Delhi Gate Aligarh 202 001 (U.P) Mob.: 9837393960/9837055622 alhamd_2008@rediffmail.com ; info@alhamdagro.com	M/s Al-Hamad Agro Food Products (P) Ltd., Village Udla Ilyaspur, P.O. Sarol, G.T. Road, Aligarh	APEDA/66	Buffalo meat	31/12/2017
18.	Mr. M.R. Farrukh General Manager M/s J.S. International 16/80-1, Civil Lines Kanpur - 2088001 Tel: 0512-2305042, 2305073 Fax: 0512 2305031 E mail: info@jsgroupindia.com ; shuzafer@jsgroupindia.com	M/s J.S. International B-32 to B-47, Leather Technology Park, Industrial Area, Banthar, Unnao	APEDA/67	Buffalo meat	31.12.2017
19.	Mr. V.I. Saleem CEO M/s. Fair Exports India (P) Ltd. 501, Madhava, Bandra Kurla Complex, Bandra East, Mumbai Tel: 0120 2771126/27/4672400 Fax: : 0120-2771125 E mail: exports@fairexports.net ;	M/s. Fair Exports India (P) Ltd. Vill Ahmednagar Pahari, Tehsil, Sadar Dist. Rampur	APEDA/68	Buffalo meat	30/4/2017
20.	Mr. Shakir Qureshi Managing Director M/s Al-Quresh Exports Rivzi Chambers, A-Wing, 3 rd Floor, R. NO. 310, Hill Road, Bandra (West), Mumbai - 400050 Tel: 022-26425930/26425934 Fax: 022-26425925 E-mail: info@al-quresh.com ; shakirqureshi@al-quresh.com	M/s Al Quresh Exports M/s Son Ankur Exports (P) Ltd. Gate No. 67, Mulegaon Tanda, N.H. No. 9, South Solapur, Solapur	APEDA/71	Buffalo meat	06.9.2018

21.	Mr. Mohd. Mustaqem Qureshi Managing Director M/s. Al- Nafees Frozen Food Exports Pvt. Ltd. 6, Central Lane, Bengali Market, New Delhi – 110001 Tel: 011-23318801, 8804, 8806, 8808 Fax 011-23318815, 19 E-mail alnafees@indb.vsnl.net.in ; vk.jain@alnafeesgroup.in	M/s. Al- Nafees Frozen Food Exports Pvt. Ltd., Hasanpur Bus Stop, Hapur Road, Dasna Distt., Ghaziabad (U.P.)	APEDA/72	Buffalo meat	27/2/2017 Extension valid upto 31.3.2017
22.	Mr. Afzal Latif President M/s. Allansons Private Limited. Allans Centre, 113/115, M.G. Road, Fort, Mumbai – 400001 Tel : 022-56569000, 22628000, Fax 022-22641133, 22691133 E-Mail: alatif@allans.com ; aziz@allans.com ;	MCD Ghaziipur Slaughter House Integrated Fright Complex, Pocket B, Behind Poultry Market, Ghaziipur, Delhi 110092 Leased to Frigorifico Allans Private Limited. A-15, Site IV, Industrial Area, Sahibabad, Ghaziabad (U.P.)	APEDA/81	Buffalo / Sheep & goat (Stand Alone Abattoir)	27.9.2017
23.	Haji Shahid Ali Qureshi Director M/s Eagle Continental Foods Pvt. Ltd. Purani Chungi, Bar road Hapur 245101 (U.P.) Tel : 0122 2313860, 2312113 Fax: 0122 2318500 Email: eaglefoods20@gmail.com ; eaglefoods20@rediffmail.com ; intekhab_alam@eaglecontinentalfoods.com .	M/s Eagle Continental Foods Pvt. Ltd. Khasra No. 1876, Post Office Hindon Nagar Dasna, Ghaziabad	APEDA/83	Buffalo/ Sheep and goat meat	29/4/2017
24.	Mr. Afzal Latif Allansons Private Limited. Allans House, 4 Allans Road, Colaba Road, Mumbai, Maharashtra Tel : 022-56569000, 22628000, Fax 022-22641133, 22691133 E-Mail: alatif@allans.com ; aziz@allans.com	Al- Hamd Frozen Foods (P) Ltd. 2 nd Km, Stone, Mundakhera Road, Khurja	APEDA/85	Buffalo meat	31/12/2017
25.	Mr. Shakeel Ahmed Managing Director M/s Al Falah Frozen Foods Mian Sarai (Qila), Tehsil Sambhal Distt. Moradabad Mob.: 9758019786 Fax : 05923 230266, 230267 E mail : alfalahfrozenfood@gmail.com ; alfalahfrozenfoods@gmail.com	M/s Al Falah Frozen Foods Village Begumpur (Ghair Abad) Chimyawali road, Sambhal Dist. Moradabad, U.P.	APEDA/95	Buffalo meat	1.3.2018
26.	Mr. Imtiyaz Hassan Khan Director Mr. Saad Khan Director M/s. Al Karim Exports Pvt Ltd 3-B Rashid Mansion, 1st and 2nd Floor , Opp. Lala Lajpath Rai College, Worli Point , Mumbai Mob: +919742594266, +919819606778, +919820073997 Email: info@alkarimexport.com ; alrahmanfrozenfoods@yahoo.in	M/s Al Rahman Frozen Foods Village Chimyawali, Moradabad Road, Sambhal, UP	APEDA/106	Buffalo meat	31.12.2018
27.	Mr. Mohd. Rizwan Director M/s India Frozen Foods Moh. Bkura, Sarai Tarwan Sambhal (Moradabad) Fax: 05923 272660 Mob.: 9412240845, 46, 47 E-mail: indiafrozenfoods@yahoo.in ; indiafrozenfoods_123@rediffmail.com	M/s India Frozen Foods Village, Begumpur, Chimyawali, Sambhal (Moradabad)- U.P.	APEDA/108	Buffalo meat	31/12/2017

28.	Mr. Mohd. Kamil Qureshi M/s. M.K. Exports, M/s Chaudhary Skin Trading Company 14, Fire Brigade Lane, Near World Trade Centre, Connaught Place New Delhi – 110001 Tel: 011-23522163, 23635400, 23679674 Fax: 23674988 E-Mail: mkgroupofindustries@gmail.com mkgroup59@gmail.com mko.nadaga@gmail.com	M/s Chaudhary Skin Trading Company D-34, Site-B, Surajpur Industrial Area, Gantam Budh Nagar, U.P	APEDA/109	Sheep and Goat	31.12.2017
29.	Mr. Mohd. Imran Managing Director M/s Al Fahoem Meatex Pvt. Ltd. 1113, Sarai Hehloom Meerut City (U.P.) Tel: 0121-2301127 Fax: 0121-2302769 Mob: 9719060786 E-mail: mf@alfohemexport.com	M/s Al Fahoem Meatex Pvt. Ltd. Alipur Dhikoli, Hapur Road, Meerut, U.P.	APEDA/111	Buffalo Meat	5/8/2017
30.	Mr. Abid Ali Al-Mazria Agro Foods E-442/2, Street No. 10 Subhash Vihar, Bhajanpura Delhi 110 053 Email : almazriagrofoods@gmail.com : abid1617@gmail.com	Al Mazria Agro Foods Khasra No. 677, 679, Village Bhagwanpura Bandra Road, Distt. Jhansi 284001, U.P.	APEDA/117	Buffalo meat	31.3.2017
31.	Mr. Gulzar Ahmed Qureshi Director M/s H.M.A. Agro Industries Ltd. 2/220, 2 nd Floor Glory Plaza Opp. Sur Sadan, M.G. Road, Agra 282002 Tel: 0562-4000188 Fax: 0562-2323230 Mob.: 09319087671 E-mail: hmasfroze@rediffmail.com ; tariqueagar@hmasagro.com ; gulzab@hmasagro.co	M/s. H.M.A. Agro Industries Ltd., 6/1, 15-16, Village – Talaspur, Tehsil Kaol, Mathura Bye pass Road, Aligarh	APEDA/119	Buffalo Meat	30/11/2016 Extension valid upto 30 th June 2017
32.	Mr. Afzal Latif President M/s. Allansons Private Limited. Allans Centre, 113/115, M.G. Road, Fort, Mumbai – 400001 Tel: 022-56569000, 22628000, 56569056 Fax: 022-22641133, 22691133 E-Mail: aaziz@allans.com	M/s. Frigerio Conserva Allans Private Limited. Plot No 14/1, Village Talaspur Khurd, Tehsil Koul, Mathura By pass road, Aligarh, Uttar Pradesh	APEDA/121 (Unit-1)	Buffalo meat	13.12.2017
33.	Mr. Shub Ahmed Managing Director M/s Mirha Exports Pvt. Ltd. 30 Bazar Lane, Bengali Market Connaught Place New Delhi – 110001 Tel: 23353271 /72 /73 Fax: 23353270 Mob : 09811091457 E-mail : ranjhan@mirhaexports.com ; shuchisharma@mirhaexports.com ;	M/s Mirha Exports Pvt. Ltd. Rani Majra Road, Jaula Khurd, Lakru Village Tehsil Darabassi, Dist. Mohali, Sas Nagar, Punjab	APEDA/125	Buffalo Meat	18/05/2017

34.	Mr. Mohammed Saleem Proprietor M/s. Mohammed Saleem # 5-9-20/A, Opp. Secretariat, Saifabad Hyderabad - 500004 Tel: 040- 23244448 / 23244447 Fax: 040 - 23244448 Mobile no. 09849078624 E mail: saleemc9@gmail.com ; info@smol-continental.com	M/s. Mohammed Saleem Changicherla Village, Ghatkesar Mandal, Hyderabad, Ranga Reddy Distt., Telangana State	APEDA/127	Buffalo / Sheep and Goat meat	6/08/2017
35.	Mr. Afzal Latif President M/s. Allansons Private Limited. Allans Centre, 113/115, M.G. Road, Fort, Mumbai - 400001 Tel: 022-56569000, 22628000, 56569056 Fax 022-22641133, 22691133 E-Mail: afatif@allans.com ; aziz@allans.com	M/s Al-Tabarak Frozen Foods (P) Ltd. Mathura By Pass Road Village Mullapara, Bhujpura Aligarh	APEDA/128	Buffalo Meat	7/7/2017
36.	Mr. Mohd. Saleem Qureshi Managing Director M/s. Rustam Foods Pvt. Ltd. 3 rd Floor, Burlington Square, Burlington Crossing, Vidhan Sabha Marg, Lucknow - 226001, U.P. Tel: +91 522 4114333 Fax: +91 522 4114334 Mob: 09324294684 / 09889869748 E-mail: info@rustamfoods.net ; rustamfoods@rustamfoods.net ; az@rustamfoods.net	M/s. Rustam Foods Pvt. Ltd. E, 28, Industrial Area, Site No. 1, Unnao 209801 Uttar Pradesh	APEDA/ 132	Buffalo meat	31/3/2017
37.	Mr. O.P. Arora Director M/s AOV Exports Pvt. Ltd. Plot No. D-1 & D-2, Industrial Area, Site -I, Unnao, Kanpur (U.P.) Tel: 0515-2829144 E mail: aziz@aovexports.com ; oparora@aovexports.com ; info@aovexports.com	M/s AOV Exports Pvt. Ltd. Plot No. D-1 & D-2, Industrial Area, Site -I, Unnao, Kanpur (U.P.)	APEDA/133	Buffalo meat	31/12/2017
38.	Ms. Shahnar Choudhary Director M/s. A.Q Frozen Foods (P) Ltd. E-22/372, 1 st Floor, Zakir Nagar Okhla, New Delhi-110025 Mob :09415607306, 9811518128 Email : md@aqfrozenfoods.in	M/s. A.Q Frozen Foods Pvt. Ltd. Kunda Feeder Road, Bachrao, Distt. J.P Nagar - 244225, UP	APEDA/135	Buffalo	2/07/2017
39.	Mr. Ashok Kale Chairman M/s Ahmednagar Dist. Goat Rearing & Co-Op Fed. Ltd. 21 Kisan Krant, Market Yard Ahmednagar - 414001, Maharashtra Fax: 0241-2450909 /2451135 E mail: kale.agf@gmail.com	M/s Ahmednagar Dist. Goat Rearing & Co-Op Fed. Ltd. Village- Dewalgaon (Sidhi), Ralegan Road, Nagar, Distt. Ahmednagar	APEDA/137	Sheep and Goat Meat	20/4/2017
40.	Mr. Afzal Latif President M/s. Allansons Private Limited. Allans Centre, 113/115, M.G. Road, Fort, Mumbai - 400001 Tel: 022-56569000, 22628000, 56569056 Fax 022-22641133, 22691133 E-Mail: afatif@allans.com ; aziz@allans.com	M/s Ichalkaranji Agro Foods R.S. No. 613, Site No. 115, Shanti Nagar Near Shanti Hotel, Thorat Chowk Ichalkaranji, Dist. Kolhapur Maharashtra	APEDA/139	Buffalo meat (stand alone abattoir)	6.11.2017

41.	M/s. Al – Dua Food Processing (P) Ltd. 16, Fire Brigade Lane, Near World Trade Centre, Connaught Place, New Delhi – 110001 Tel: 011 41525900 Fax: 011 23413093 E-mail : alduafood786@gmail.com	M/s. Al – Dua Food Processing (P) Ltd Village Amarapur Kodla, Tahsil Cole, Mathura By Pass Road, Distt. Aligarh (U.P.)	APEDA/140	Buffalo meat	31/3/2017
42.	M/s. Frigorifico Allana Private Limited. Allana House-2, Allana Road, Mumbai Tel : 022-56569000, 22628000, 56569056 Fax 022-22641133, 22691133 E-Mail: alatif@allana.com ; aazis@allana.com	M/s. Modern Slaughter House (Agra Nagar Nigam), Plot No. 287, Vill-Kuberpur, Tahseel Aitmadpur, Agra	APEDA/143	Buffalo meat (Stand Alone Abattoir)	13.9.2017
43.	Mr. Suraj Ahmed Qureshi Director M/s Rayban Foods Private Ltd. T301, 302, 3 rd Floor, LSC No.6, Chetan Complex, Shreshtha Vihar Delhi-110092 Tel: 011 32327172, 32328182, 0122 2302580, 2317786 Fax: 0122 2302920, 2300486 Email: info@raybangroup.net ; sirajahmedqureshi@yahoo.com & Dr. M. Naseem Qureshi M/s. Aliffa Agro (India) Pvt. Ltd. 246, 2 nd Floor, Tribhuvan Complex Ishwar Nagar, Mathura Road, New Delhi-110065 Tel: 26312225, 26312226 Fax: 26312224 E-mail: aliffa@aliffaindia.com	M/s Rayban Foods Private Ltd., Rampur Marg, Bulandshahr Road, Hapur, U.P.	APEDA/146	Buffalo meat	31.12.2018
44.	Mr. S. Sasti Kumar Director M/s. Ponne Products Exports 3 rd Floor, Ponne Plaza, Paramathi Road, Namakkal – 637001 Tamil Nadu Fax: +91 4286 232542, 220719 Mob: +91 9629666611 E-mail: director@ponni.in ; exports@ponni.in	Dimapur Municipal Council Through Look East Construction Pvt. Ltd., Katkati road, Burma Camp, Dimapur, Nagaland	APEDA/148	Buffalo Meat	20.11.2017
45.	Mr. Salahuddin Director M/s. Meem Agro Foods Pvt. Ltd. T-239, 1 st Floor, Gali Haji Ameer Baksh Quresh Nagar Sadar Bazar Delhi-110006 Tel: 23513706, 23626691 Fax: 23623394 E-mail : meemagro@gmail.com	M/s. Meem Agro Foods Pvt. Ltd. 993 to 1005, Kandhla Road, Kairana, Distt-Shamli, U.P.	APEDA/149	Buffalo Meat	28/5/2017
46.	Mr. Mujahid Aslam Director Mash Agro Foods Ltd. 15/7-A, Civil Lines Kanpur 208001 (U.P) Tel : 0512 3002060 E mail : mashgroup@gmail.com ; info@mashagrofoods.com ; info.mashagro@gmail.com ; Mob: 9839008074 ; 08400699997, 09506981265, 09336248707	M/s. Mash Agro Foods Ltd. Village Bichpuri, Tehsil-Hasanganj, Pargana Ajgaon, Unnao-UP	APEDA/150	Buffalo Meat	30/4/2017

47.	Mr. Shakeel Qureshi Managing Director M/s Marya Frozen Agro Foods Pvt. Ltd. A-16, 1 st Floor, Butler Plaza, 95-Civil Lines, Bareilly-243001, UP Tel: 0581-2550144 Email: Chairman@marvaagro.com ; managingdirector@marvaagro.com	Marya Frozen Agro Foods Pvt. Ltd. Mohampur Sahajampur Road, Bareilly, U.P	APEDA/151	Buffalo Meat	1/07/2017
48.	Mr. Riyaz Abdul Kader Director M/s. Mark International Foods Stuff Pvt. Ltd. Plot No. 31/33, Mafco A P M C Yard Sector - 18, Vashi Navi Mumbai 400 703 Tel.: 022 27889741 Fax: 022 27888743 Email : markinter@vsnl.net ; markaccoun@vsnl.net ; export@markfoods.co & M/s. RLM Food Stuff Pvt. Ltd. Shop No. 14A / 15A, 1 st Basement, Ashoka Shopping Centre, L.T. Road, Mumbai	Sangli Miraj Kupwad City Municipal Slaughter House, Bedak Road, Miraj - 416420 Sangli, Maharashtra Leased to Mark International Foods Stuff Pvt. Ltd. and RLM Food Stuff Pvt. Ltd.	APEDA/154	Buffalo Meat (Stand Alone Abattoir)	20.11.2017
49.	Mr Intiyaz Hassan Khan Director Mr. Saad Khan Director M/s. Al Karim Exports Pvt Ltd 3-B Rashid Mansion, 1st and 2nd Floor, Opp. Lala Lajpath Rai College, Worli Point, Mumbai Mob: +919742594266, +919819606778, +919820073997 Email: info@alkarimsexport.com	M/s. Tapi Valley Agro Foods Products Co. 123, Mohammediya Nagar, Dhule Road, Dondaicha Taluka, Shindekheda, Dist. Dhule- 425408 Maharashtra	APEDA / 155	Buffalo Meat (Stand Alone Abattoir)	31.10.2017
50.	Mr. Waziruddin Allauddin Chairman/Managing Director M/s. Al-Hasan Agro Foods Pvt. Ltd. 4/80, Kabir Colony Annapalshahar Road, Aligarh, U.P. Email : alhasan.wazir@yahoo.com Mob: 09458633600, 09045538429	M/s. Al-Hasan Agro Foods Pvt. Ltd. Plot No. 219 MI Village Amarpur Kondla, Mathura Bye Pass Road, Aligarh (U.P.)-202001	APEDA / 157	Buffalo Meat (Stand Alone Abattoir)	11/4/2017
51.	Mr. K. Rajendran M/s. Asvini Agro Exports No. 3, 2 nd Canal Cross Road, Gandhi Nagar, Adyar, Chennai Mob: 09440188252 E-mail: asvini@asvini.co.in	M/s. Asvini Agro Exports R.S. No. 129, Ananthasagaram (V), Vatugodipadu (P), Agripalli (M), Krishna District, Andhra Pradesh	APEDA/160	Buffalo Meat (Stand Alone Abattoir)	30.11.2017
52.	Mr. Shakir Hussain Qureshi Director M/s Al Nasir Exports Pvt. Ltd. 7A/42, WEA, Western Chamber Karol Bagh, New Delhi 110 005 Tel.: 23865645 Fax: 23745694 Email: al_nasir@rediffmail.com ; info@alnasirexports.com	M/s. AL Nasir Exports Pvt. Ltd., Plot No. 2761, Bhooagarhi, Dausa, Distt. Ghaziabad, U.P.	APEDA/161	Buffalo Meat	31/12/2017
53.	Mr. Gulzeb Ahmed M/s. Federal Agro Industries Pvt. Ltd 903, 9 th Floor, Akashdeep Building 26 Barakhamba Road New Delhi 110 001 Tel: 23329154 Mob.: 8954004949/7895622222 Email: ahraf@fimgroup.co ; gulzeb@fimgroup.co info@federalagro.com	M/s. Federal Agro Industries Pvt. Ltd Village Bahra, Barwala Road, Tehsil -Darabassi, Distt. Ajitgarh, Punjab	APEDA/164	Buffalo Meat	17/04/2018

54.	Mr. Mohd. Kamil Qureshi Managing Director M/s. M.K. Overseas Pvt. Ltd. 14, Fire Brigade Lane, Near World Trade Centre, Connaught Place New Delhi - 110001 Tel: 011-23522165, 23635400, Fax: 23674988 E-Mail: mkgroupofindustries@gmail.com mkco@nda.vsnl.net.in	M/s Tanya Marketing Private Limited Khasra No. 81 Allipur Jigmuna, Hapur Road Meerut, U.P.	APEDA/165	Buffalo meat	31.7.2017
55.	Mr. Raja Shahensha Shaikh SES Company, A-17, Ground Floor, Shahensha Compound, C.S. No. 312 Dharkavi Road, Mahim East Mumbai Tel: 9323609664 Email: ra.shk@icloud.com and Mohammed Ali Khan Reliable Agro Foods Gut No. 160-161, Village-Kanadkhed Tal-Purna, Distt. Parbhani Maharashtra Email : reliableagrofoods@gmail.com reliablecoldstorage@gmail.com	Reliable Agro Foods Gut No. 160-161, Village-Kanadkhed Tal-Purna, Distt. Parbhani Maharashtra reliableagrofoods@gmail.com	APEDA/166	Buffalo meat	31/10/2017
56.	Mr. Afzal Latif President M/s. Allansons Private Limited. Allans Centre, 113/115, M.G. Road, Fort, Mumbai - 400001 Tel: 022-56569000, 22628000, 56569056 Fax 022-22641133, 22691133 E-Mail: afatif@allans.com ; afaz@allans.com	M/s Laham Exports India Pvt. Ltd. 2, KM Stone, Moonda-Khera Road Khurja 20313 (U.P)	APEDA/167	Buffalo meat	3/8/2018
57.	Mr. Shakir Husain Qureshi Director Al Nasir Exports Pvt. Ltd. 7-a/42, W.E.A Western Chamber Channa Market, Pusa Road Karol Bagh, New Delhi Tel : 49097786 Fax: 41452036 Email : info@alnasirexports.com	Kolkata Municipal Corporation 74, D.C. Dey Road, Tangra Kolkata, West Bengal	APEDA/169	Buffalo meat (stand alone abattoir)	31.5.2017
58.	Mr. Shameem Qureshi Director Al Sameer Exports Pvt. Ltd. C-107, 108 First Floor, Metro Plaza Delhi Road, Meerut Tel: 0121 4010399/6452030 Email : shameemqureshi@yahoo.co.in	Al Sameer Exports Pvt. Ltd. Village Gogi Pothia thana Simraha Forbesganj District Araria Bihar	APEDA/170	Buffalo meat	7.9.2018
59.	Mr. Ateeq Ahmed Director M/s Omar International Pvt. Ltd., 303A-303B, 3 rd Floor, Sagar Complex, Plot No. 5, New Rajdhani Enclave, Delhi - 110 092 Tel: 43108405 Telefax: 22041409 Email: ateeq.omarinternational@gmail.com	M/s Omar International Pvt. Ltd., Khasra No. 47, 52 & 54 Village Yaqoobpur, P.O. Sahaspur, District Bijnor, UP	APEDA/173	Buffalo meat	6/10/2018
60.	Mohd. Shoaib Ali Khan Director M/s. Fresh "N" Frozen Food Tech (P) Ltd., 9-4-77/A/156, 3 rd Floor	M/s. Fresh "N" Frozen Food Tech (P) Ltd. Sy. No. 63, Amberpet Hyderabad, Andhra Pradesh	APEDA/177	Buffalo / sheep and goat meat	3.4.2018

	Al-Hanuth Colony Towlchoki Hyderabad Tel: 040-66683945 Email: freshfrozenfoodtech@gmail.com				
61.	Mr. Gubrez Qureshi Director International Agro Foods Plot No. 2764, Bhoor Garhi Dasna, Distt. Ghaziabad (U.P.) Mob. no. : 919920775533 Email : albarzan03@gmail.com ; internationalagrofoods@cyberon.com ;	International Agro Foods Plot No. 2764, 2765, 2766, Bhoor Garhi, Dasna, Ghaziabad (U.P.)	APEDA/180	Buffalo meat	29/4/2017
62.	Mr. Abdul Salam Managing Director M/s. Al-Sami Agro Products Pvt. Ltd. Plot No. E-16, 17 & 18 Industrial Estate Dowlaiswaram - 533125 East Godavari District, Andhra Pradesh Tel: 0883-2419010/09885844786, 09949331234 Fax: 0883-2416234 Email : alsamiabdulsalam@gmail.com ; info.alsamiagro@gmail.com	Al-Sami Agro Products Pvt. Ltd. R.S. No. 109, Ramannapalem (V), Sankavaram (M), E.G. District, Andhra Pradesh	APEDA/181	Buffalo meat	7/06/2017
63.	Mr. Afzal Latif President M/s. Allansons Private Limited. Allans Centre, 113/115, M.G. Road, Fort, Mumbai - 400001 Tel: 022-56569000, 22628000, 56569056 Fax 022-22641133, 22691133 E-Mail: afzalif@allansa.com ; azais@allansa.com	Al Fair Enterprises Gut No. 190/1, 190/2, at Post Daregnon shivar Daregnon, Tal.-Malegaon District Nashik, Maharashtra	APEDA/182	Buffalo meat (stand alone abattoir)	6.10.2017
64.	Mr. VI Saleem CEO M/s. Fair Exports India (P) Ltd. 501, Madhava, Bandra Kuria Complex, Bandra East, Mumbai Tel: 0120 2771126/27/4672400 Fax: : 0120-2771125 E mail: exports@fairexports.net	M/s Fair Exports (India) Pvt. Ltd. Gut No. 232/233, Daregnon, Taluka Malegaon, Distt. Nashik 423203, Maharashtra	APEDA/183	Buffalo meat	22.7.2017
65.	Mr. Abhishek Arora Director M/s AOV Agro Foods Pvt. Ltd. J-18, Sector 18, NOIDA 201301 U.P. Tel. :4292929 Email : aov@vsnl.net	M/s AOV Agro Foods Pvt. Ltd. Village Tapkan District Meerut (Nuh) - 122107	APEDA/186	Sheep meat	16/11/2017
66.	Mr. Mohdsham Ahmed Khan M/s. I Ahmed and Co. (Cold Storage and Exports) Pvt. Ltd. Plot No. 34-36, Sector - 18, Mafco Yard, APMC, Vashi, Navi Mumbai 400 705 Tel: 27888745, 27888325, Email : contact@iahmed.com & Mr. Abdul Qayyum Qureshi, Mr. Mohammed Inuran M/s Samman International Pvt. Ltd. Plot No. 34-36, Sector - 18, Mafco Yard, APMC, Vashi, Navi Mumbai 400 705 Tel: 23464253 Email : sammaninternational@hotmail.com	Vizag Foods Pvt. Ltd. Survey No. 162, Modern Abattoir Complex Marikvalasa, Visakhapatnam Andhra Pradesh	APEDA/187	Buffalo meat	6/01/2018

67.	Mr. Javed S Qureshi M/s Javed Qureshi Exports 601-605, 6 th Floor Guruvidya CHS, 98/A Hill Road, Bandra (W) Mumbai Email : javedqureshiexports@gmail.com	Al-Raiyan Export Gut No. 231/2, Village- Daregaon Tal-Malegaon Dist. Nashik Maharashtra	APEDA/189	Buffalo meat	20/01/2018
68.	Mr. Sunny Khattar Partner Maharashtra Foods Processing and Cold Storage 21/2B, Algendewadi, Phaltan Distt. Satara Maharashtra 415523 Tel.: 09818884347 Email : mahafoodsvar@gmail.com	Maharashtra Foods Processing and Cold Storage Gut No. 21/2 B, 22/4A/1, 22/4A2, 22/4AB Baramati Road, Algendewadi, Phaltan Distt. Satara, Maharashtra 415523	APEDA/190	Buffalo meat	28/2/2018
69.	Mr. Ahmed Darmani Executive Director M/s Al Saad Exports Pvt. Ltd. Flat No. 105, Madina Gulshan, Masab Tank Hyderabad, Telangana, Pin 500 028 Mob.: 9885555558 Email : ahmeddarmani@gmail.com	Greater Hyderabad Municipal Corporation (GHMC) Abattoir Ramnathpura, Hyderabad 500 064 Leased to M/s Al Saad Exports Pvt. Ltd.	APEDA/191	Buffalo meat (Stand Alone Abattoir)	24.4.2017
70.	Mr. Mohammad Zubair Nagani Director M.U.N. Agro Industries Pvt. Ltd. 634, Commodity Exchange Bldg., Sector - 19/A, Vashi Navi Mumbai 400 705, Maharashtra Tel.: 022 27840132/33 Fax: 022 27846533 Mob.: 9821499678 Email : munagroindustries@gmail.com	M.U.N. Agro Industries Pvt. Ltd. Gut No. 102/EP, 98/2P, Village Kurunse Tal-Vikramgadha, Dist Palghar, Maharashtra	APEDA/193	Sheep/goat meat	30.6.2017
71.	Mr. Mujeeb Malik Joint Managing Director ALM Food Products Limited 43 Qutab Sher Market Ambala Road Sahasrampur 247001 (U.P.) Tel. : 9756702294, 9837019192 Email : info@almfoods.com ; mdalm786@gmail.com ; mumalik131@rediffmail.com	ALM Food Products Limited Village Bahra, Tehsil Darabassi District Sas Nagar, Punjab	APEDA/195	Buffalo meat	30.9.2017
72.	Mr. Mohammad Mustaqeem Qureshi Managing Director M/s. Al-Nafees Proteins Private Limited 6, Central Lane, Bengali Market, New Delhi - 110001 Tel: 011-23318801, 8804, 8806, 8808 Fax 011-23318815, 19 E-mail : alnafees@ndb.vsnl.net.in ; vk.jain@alnafeesgroup.in	Al Nafees Proteins Pvt. Ltd. Village Satalpuri, Tehsil Punahana District Meerut At Nuh, Haryana	APEDA/196	Buffalo meat	30.9.2017
73.	Mr. Mohd. Atif Director Al Ammar Frozen Foods Exports Pvt. Ltd. 8358, First Floor, Model Basti Sadar Bazar Near Pahar Ganj Delhi 110 006 Tel.: 46521590 Email : atif@alammar.in	Al Ammar Frozen Foods Exports Pvt. Ltd. Village Amarpur Kodra, Tehsil Kol, District Aligarh, U.P	APEDA/197	Buffalo meat	31.12.2017
74.	Mr. Bushara Zakariya Director M/s Zakariya Agro Pvt. Ltd. 40/69-C-1, Jaw Press Compound Parade Kanpur 208 001, Uttar Pradesh Tel.: 512 2314479	M/s Zakariya Agro Pvt. Ltd. NH-57, gogi Photohiya Simraha forbes Ganj Arraria, Bihar	APEDA/198	Buffalo Meat	2.2.2020

	Mob.: 9839414010 Email: kushzakariya@gmail.com ; zakariyaexport@rediffmail.com				
75.	Mr. Kamal Verma Managing Director M/s Standard Frozen Foods Exports Pvt. Ltd. 2-1/1347, New Shivpuri Hapur 245101, (India) Mob.: 9837031205 Email: kuv@standard.net.in ; info@standard.net.in	Standard Frozen Foods Exports Private Limited Gate No. 84,86,95, Village- Chandpur Near E-20, Site I, UPSIDC Industrial Area, Unnao, U.P.	APEDA/199	Buffalo meat	20.8.2017

Meat processing plants registered with APEDA for export of meat from India

Sl. No.	Name of the Exporter and Contact Person	Processing unit(s) registered with APEDA	Registration No.	Validity of registration up to	Agreement with Slaughter house and meat plant Registration No.
1.	Mr. Mohd. Kamil Managing Director M/s. M.K. Overseas Pvt. Ltd. 39/5864, Basti Harphool Singh, Sadar Bazar Delhi - 110006 Tel: 011-41525900 Fax: 011-23413093 E-Mail : mkgrouppofindustry@gmail.com	M/s M.K. Overseas Pvt. Ltd., B-63-64, Site-IV, Sahibabad Industrial Area, Distt. Ghaziabad U.P.	APEDA/06	20.10.2017	M/s. M.K. Overseas Pvt. Ltd., Derabassi, Punjab APEDA/55
2.	Mr. Mubashir Ahmed Khan Director M/s I. Ahmed & Company (Cold Storage & Exports) Pvt. Ltd. No. 34-36, Mafco A.P.M.C, Sector-18, Vashi Navi Mumbai - 400705 Tel : 022-2788 8745 Fax : 022- 2788 8771 Email : contact@iahmed.com ;	M/s I.Ahmed & Company (Cold Storage and Exports) Pvt. Ltd. Plot No. 34-36, MAFCO A.P.M. Sector 18, Vashi Navi Mumbai	APEDA/13	6/10/2017	M/s Vizag Foods Pvt. Ltd. , Visakhapatnam Andhra Pradesh APEDA/187
3.	Mr. Afzal Lanif President M/s. Allanasons Private Limited. Allana Centre, 113/115, M.G. Road, Fort, Mumbai - 400001 Tel : 022-66569090, 22628000 Fax 022-22641133, 22691133 E-Mail afzalif@allana.com ; aaziz@allana.com	M/s. Frigorifico Allana Private Limited. A-15, Site-IV, Industrial Area, Sahibabad, Ghaziabad (U.P.)	APEDA/18	31.12.2017	M/s. Frigorifico Allana Private Limited - MCD Ghazipur Slaughter House, Delhi APEDA/81 M/s Al Nasir Exports Pvt. Ltd. APEDA/161 M/s Al Saqib Exports Pvt. Ltd. APEDA/49
4.	Mohd. Raif Director M/s. Fair Exports India (P) Ltd. 501, Madhava, Bandra Kurla Complex, Bandra East, Mumbai Tel: 26590176/80 Fax: : 26592326 E-mail: exports@fairexports.net ; raifat@fairexports.net ;	M/s Fair Exports (India) Pvt. Ltd., 20/1, Site IV, Industrial Area, Sahibabad, Ghaziabad (U.P.)	APEDA/31	31.12.2017	M/s. Amroon Foods Pvt. Ltd., Barabanki APEDA/68
5.	Mr. Ajay Sud Partner M/s Miki Exports International C-4/10, Safdarjung Development Area, New Delhi 110016 Tel:011-27575516 Fax :011-27575512 Mob.: 91 98 200 69178 E-mail: ajay@mikiexports.com ; sumi@mikiexports.com ; mukialnoor@gmail.com	Miki Exports International M-43, MIDC Taloja (Ground Floor) Distt. Raigad New Bombay	APEDA/35	23.5.2017	M/s Al Noor Exports Muzaffarnagar APEDA/56 M/s Al Raiyan exports Maharashtra APEDA/189

6.	Mr. Afzal Latif President M/s. Allana Sons Ltd. Allana Centre, 113/115, M.G. Road, Fort, Mumbai - 400001 Tel : 022-66569090, 22628000 Fax: 022-22641133, 22691133 E-Mail: alatif@allana.com ; aaziz@allana.com	M/s Anjaneya Cold Storage Ltd., Plot No. B- 35, Lawrence Road, New Delhi	APEDA/44	16.1.2019	M/s. Frigorifico Allana Ltd., Ghazipur, Delhi APEDA/81
7.	Dr. S K Ranjhan Director M/s Mirha Exports Pvt. Ltd. 30 Bazar Lane, Bengali Market Connaught Place New Delhi - 110001 Tel: 23353271 /72 /73 Fax: 23353270 Mob : 09811091457 E-mail : ranjhan@mirhaexports.com ; shuchisharma@mirhaexports.com	M/s Mirha Exports Pvt. Ltd B-36, Site-IV, Sahibabad Industrial Area, Distt. Ghaziabad U.P.	APEDA/51	31.12.2017	M/s. Mirha Exports Pvt. Ltd., Mohali, Punjab APEDA/125 M/s India Frozen Foods , Moradabad, U.P. APEDA/108
8.	Mr. Afzal Latif President M/s. Allana Sons Ltd. Allana Centre, 113/115, M.G. Road, Fort, Mumbai - 400001 Tel : 022-66569090, 22628000, 56569056 Fax: 022-22641133, 22691133 E-Mail: alatif@allana.com ; aaziz@allana.com	M/s. Arshiya Exports Pvt. Ltd., B-67, Site-IV, Industrial Area Sahibabad, Dist. Ghaziabad, U.P.	APEDA/52	31/12/2017	M/s. Frigorifico Allana Ltd., Ghazipur MCD Slaughter House APEDA/81
9.	Dr. M. Naseem Qureshi Director M/s Al- Junaid Foods (P) Ltd Khasra No. 172, Alipur Jijwana Hapur Road, Meerut E-mail: aljunaidfp@gmail.com ; sirahmedqureshi@yahoo.com	M/s Al- Junaid Foods (P) Ltd. Khasra No. 172, Alipur Jijwana Hapur Road, Meerut	APEDA/69	29.11.2017	M/S Tanya Marketing Private Limited Meerut, U.P. APEDA/165
10.	Mr. Abdul Wajid Shaikh Director M/s SRK Cold Storage Pvt. Ltd. 316/317, Commodity Exchange Building, Plot No. 2,3 & 4 Opp. Mathadi Bhavan, Sector 19, Vashi, Mumbai Tel: 022 27845571 Fax: 022 27815572 Email : fizaexports@yahoo.co.in ; ziri@fizaexports.in	M/s SRK Cold Storage Pvt. Ltd. Plot No. 7,8,34,35, IDA, Peddapuram, East Godavari District, Andhra Pradesh	APEDA/76	9.8.2017	M/s Varsha Fresh Meats Products Ltd. Govindapuram, Palakkad APEDA/78
11.	Mr Imtiaz Hassan Khan Director Mr. Saad Khan Director M/s. Al Karim Exports Pvt Ltd 3-B Rashid Mansion, 1st and 2nd Floor , Opp. Lala Lajpath Rai College, Worli Point , Mumbai Mob: +919742594266, +919819606778, +919820073997 Email: info@alkarimexport.com	M/s. Charis Agro and Cold Storage, Plot No. 1313 (P) Auto Nagar, Kanbargo, Belgaum-590015	APEDA/79	30/6/2017	M/s. Tapt Valley Agro Food Products APEDA/155
12.	Haji Shahid Akhlaq Director Al-Saqib Exports Pvt. Ltd.	Al Yasir Exports Pvt. Ltd. Village Alipur Jijwana Hapur Road Meerut, U.P	APEDA/82	4/5/2017	M/s Al Saqib Exports Pvt. Ltd, Meerut

	11 Km Milestone, Village Alipur Jijwana, Meerut, U.P. Email : info@alsaqibsports.com ; mjaved50@gmail.com ;				APEDA/49
13.	Mr. Haji Habib Ahmed Director M/s Al Takbeer Frozen Foods Pvt. Ltd. 8100, 8200 Bara Hindu Rao, Delhi Pin 110 006 Mob : 9837042076 Email : altakbeerfrozenfoods@gmail.com	M/s Al-Takbeer Frozen Food (P) Ltd. Munda Khara Road, Khurja, Distt. Bulandshahar, U.P.	APEDA/88	18.5.2017	M/s Al Felman Frozen Foods APEDA/106
14.	Mohd. Tauseef Director M/s Al-Hamd Agro Food Products Pvt. Ltd. Sara Miyan, Delhi Gate Aligarh 202 001 (U.P) Mob : 9837393960/9837055622 alhamd_2008@rediffmail.com ; info@alhamdagro.com	M/s Al Taseen Frozen Food Exports Pvt. Ltd. 2 nd Mile Stone, Munda Khara Road Khurja, Distt. Bulandshahar, U.P.	APEDA/ 90	7/8/2017	M/s. Al-Hamd Frozen Foods Pvt. Ltd., Aligarh APEDA/66
15.	Mohd. Harris Director M/s Hamd Foods (P) Ltd. 6478, Nawab Road, Sadar Bazar Delhi -110006 Tel: 9811871794 Tel : 23534978 , 23556794 Fax: 23547770 E mail : harrisqureshi4@gmail.com ; hamdfoods@gmail.com	M/s Hamd Foods (P) Ltd. B 44-45 & 65-66 Massorie Gulawthi Road, UPSIDC Industrial Area, Distt. Ghaziabad, U.P	APEDA/93	31.12.2017	M/s Al Dua Food Processing Pvt. Ltd. APEDA/140
16.	Mr. Mohd Dilshad Director M/s Anna Associate (P) Ltd. 5143, Quresh Nagar, Sadar Bazar New Delhi 110 006 Tel: 23612973 Fax: 23610946 E-mail: anna_associatespvtltd@yahoo.in	M/s Anna Associate (P) Ltd. Plot 108, Site 4, Sahibabad Industrial Area, Sahibabad Distt. Ghaziabad, U.P.	APEDA/94	6/10/2017	M/s. Al - Dua Food Processing (P) Ltd., Aligarh APEDA/140
17.	Mr. Mohd. Kamil Managing Director M/s. M.K. Oversens Pvt. Ltd. 16, Fire Brigade Lane, Near World Trade Centre, Connaught Place, New Delhi - 110001 Tel: 011 41525900 Fax: 011 23413093 E-mail : alduafood786@gmail.com	M/s. Al-Anam Agro Foods Pvt. Ltd., Talaspur Khurd, Delhi Mathura Bypass Road Aligarh, U.P.	APEDA/103	28.10.2017	M/s. Al Dua Food Processing plant APEDA/140
18.	Mr. Mohd Saleem Partner M/s M D Frozen Food Exports T-239, IIIrd Floor, Gali Haji, Ameer Bakhsh, Quresh Nagar, Sadar Bazar, Delhi 110 006 Tel: 23513709, 23518688, 64705842 Fax: 23517686 E-mail: mdfrozen786@gmail.com ; mdfrozen1993@gmail.com	M/s M D Frozen Food Exports Khasra No. 2683,2684, 2685, 2686 and 2689 Bhurgarhi Road, Village Dasna District Ghaziabad 201001, U.P.	APEDA/104	8/9/2017	M/s. Meem Agro Foods Pvt. Ltd. Distt. Shamli, UP APEDA/149
19.	Mr. Mohd. Parvez	M/s. Al-Kaif Industries	APEDA/115	20.10.2017	M/s. Al - Saqib

	M/s Al Kaif Industries 595/31, Allipur Jijwana Near Naugaza Peer Hapur Road Meerut, Uttar Pradesh Mob : 9557866786 Office: 2957866 Email : alkaifind@gmail.com	595/31, Allipur Jijwana, Near Naugaza Peer JHapur Road, Meerut, U.P.			Exports (P) Ltd., Meerut APEDA/ 49
20.	Mr Afzal Latif President M/s. Allanasons Private Limited. Allana Centre, 113/115, M.G. Road, Fort, Mumbai – 400001 Tel: 022-56569000, 22628000, 56569056 Fax 022-22641133, 22691133 E-Mail: E-Mail: afzalif@allana.com ; aziz@allana.com	M/s. Frigerio Conserva Allana Private Limited. Plot No 182, Amarpore Kondla, Tehsil Koil, Mathura By pass Road, Aligarh, Uttar Pradesh	APEDA/121 (Unit-2)	20.9.2017	M/s. Frigerio Conserva Allana Private Limited. APEDA/121 (Unit-1) M/s. Modern Slaughter House Agm - (Lensed to M/s. Frigonifico Allana Private Limited. APEDA/143
21.	Mohd. Sajid Akhlaq Al-Aqsa Frozen Food Exports 11 KM Stone, Hapur Road Village Alipur, Jijwana Distt. Meerut, U.P. Sajid.akhlaq21@gmail.com Mob : 9837080786 Arham.khan25@gmail.com Mob. 9760967856	Al-Aqsa Frozen Food Exports 11 KM Stone, Hapur Road Village Alipur, Jijwana Distt. Meerut, U.P.	APEDA/123	25.4.2017	M/s Al Saqib Exports Pvt. Ltd. Meerut, U.P. APEDA/49
22.	Mr. Chand Miyajan Qureshi Director M/s Bushra Foods (P) Ltd. Plot No. G-3 & G-4 MIDC Industrial Area Talaja Dist. Raigad Maharashtra – 410208 Tel: 022- 27412671, 27412661 Fax No. : 27411155 E mail: bushra.foods@gmail.com	M/s Bushra Foods (P) Ltd. Plot No. G-3 & G-4 MIDC Talaja Dist. Raigad Maharashtra	APEDA/ 126	31.8.2017	M/s. Mark International Foods Stuff Pvt. Ltd. APEDA/154
23.	Mr. Shakir Hussain Qureshi Director M/s Al Nasir Exports Pvt. Ltd. 7A/42, WEA, Western Chamber Karol Bagh, New Delhi 110 005 Tel: 25865645 Fax: 25745694 Email: al_nasir@rediffmail.com ; info@alnasirexports.com	M/s. Karan Frozen Foods Khasra No. 2770-72, Near Ganga Paper Mill, Boogarahi, Dasna, Ghaziabad (U.P.)	APEDA/130	31/8/2017	M/s Al Nasir Exports Pvt. Ltd. APEDA/161
24.	Mr. Mohd. Shameem Qureshi Al Sameer Exports Pvt. Ltd. 10/14, Thakur Ki Khothi Opp. Nagar Nigam Kaisar Ganj Meerut, Uttar Pradesh 250 002	M/s Zam Zam Frozen Foods Pahari Gate, Kaimry Road 1.7 K.M. Distt. Rampur 244901, U.P.	APEDA/134	10.5.2017	M/s Rayban Foods Pvt. Ltd. APEDA/146
25.	Mr. Mohd. Zahid Director M/s Al-Shifa Frozen Foods Pvt. Ltd. Azad Hind Pottery G T Road Khurja 203131 (U.P). Email : corp@shifa@gmail.com ; akpandev75@gmail.com	M/s. Al-Shifa Frozen Foods Pvt. Ltd. Mundakhara Road, Khurja – 203131 Dist. Bulandsahr U.P.	APEDA/147	31.12.2017	M/s A Q Frozen Foods Pvt. Ltd. APEDA/135
26.	Mr Riyad Abdul Kader Director M/s Mark International Foods Stuff Pvt. Ltd. 31, MAFCO, APMC Yard	M/s Mark International Foods Stuff Pvt. Ltd. 31, MAFCO, APMC Yard Sector 18, Vashi Navi Mumbai 400073	APEDA/156	26/12/2017	M/s Mark International Foods Stuff Pvt. Ltd. APEDA/ 154

	Sector 18, Vashi Navi Mumbai 400073 Tel: 022 27889741/42 Fax: 022 27888743 E-mail : markinter@vsnl.net Website : www.mark-int.com				
27.	M/s Tanya Marketing Private Limited Khasra No. 81 Alipur Jijmana, Hapur Road Meerut, U.P.	M/s. Al-Shavez Frozen Foods Pvt. Ltd. 779, Alipur Jijmana Hapur Road, Meerut (U.P.)	APEDA/158	9.5.2017	M/s. Tanya Marketing Pvt. Ltd. APEDA/165
28.	Mr. K. Rajendran M/s. Asvini Agro Exports No. 3, 2 nd Canal Cross Road, Gandhi Nagar, Adyar, Chennai Mob: 09440188252 E-mail: asvini@asvini.co.in	M/s. Asvini Agro Exports Plot No. 12, Phase III IDA A D B Road, Peddapuram East Godavari District	APEDA/159	30.3.2017	M/s. Asvini Agro Exports APEDA/160
29.	Mohd. Zulfiqar M/s. Sarah Foods M-166, 4 th Floor, Azad Apartments, Plot No. 111, I.P. Extension, Patpar Ganj, Delhi - 110092 Tel: 22500786 Mob: 9312767799, 9810910007 E-mail: alsarahfoods@gmail.com ; sarah.foods@yahoo.com	M/s. Sarah Foods Yakooogur, Sahaspur, Bijnor, Uttar Pradesh	APEDA/162	28.10.2017	M/s. Hind Agro Industries Ltd. APEDA/24
30.	Mr. Shakir Hussain Qureshi Director M/s Al Nasir Exports Pvt. Ltd. 7A/42, WEA, Western Chamber Karol Bagh, New Delhi 110 005 Tel: 25865645 Fax: 25745694 Email: al_nasir@rediffmail.com ; info@alnasirexports.com	M/s Al Nasir Agro Foods 1 Mohdipur, Bastur Sambhal Road Moradabad, U.P.	APEDA/171	28.7.2017	M/s Al Nasir Exports Pvt. Ltd. APEDA/161
31.	Mr. Qaiser Hussain Qureshi Managing Director M/s Al Aali Exports Pvt. Ltd. 1 st Floor, 5 Bazar Lane, Bengali Market, New Delhi Tel. 23327745 Mob : 9999847472 Email : qaiser@alalalexports.com ; jauzvi@alalalexports.com	M/s Al Aali Exports Pvt. Ltd. B-37, Site IV Industrial Area, Sahibabad, District - Ghaziabad, U.P.	APEDA/172	31.12.2017	M/s Nagar Nigam slaughter house APEDA/144 M/s Hind Agro Industries Ltd. APEDA/24
32.	Mohd. Shoeb Ali Khan Director M/s. Fresh "N" Frozen Food Tech 9-4-77/A/156, 3 rd Floor Al-Hasnath Colony Towlichoki Hyderabad Tel: 040-66688945 Email: freshnfrozenfoodtech@gmail.com	M/s. Fresh "N" Frozen Food Tech Sy. No. 580/581 Mangalpalle Village Ibrahimpatnam Mandal, Ranga Reddy District, Telangana State	APEDA/176	3.4.2017	M/s Fresh N Frozen Food Tech Pvt. Ltd. APEDA/177
33.	Mr. S K Wazir Shaheen Frozen Foods Cut No. 193, Taroda, Shegaon, Dist. Buldhana, Maharashtra Mob : 9423852786/9049852786 Fax: 07257 222119 Email : sfrozenfoods@gmail.com ; shaheenfrozenfoods@ymbo.in	Shaheen Frozen Foods Cut No. 193, Taroda, Shegaon, Dist. Buldhana, Maharashtra	APEDA/184	1.1.2018	M/s Fresh "N" Frozen Food Tech (P) Ltd. APEDA/177
34.	Mr. Yousuf Mujahid Managing Director	Telangana Foods Private Limited	APEDA/192	26.4.2017	Greater Hyderabad Municipal Corporation
	M/s Telangana Foods Private Limited Survey No. 422, NH-44, Kallakal Village, Toopran Mandal Medak Dist. Talangana State 502 336 Tel: 08454 250666 Fax: 08454 250555 Email : info@tfoods.in ; ahmeddarmani@gmail.com	Survey No. 422, NH-44, Kallakal Village, Toopran Mandal Medak Dist. Talangana State 502 336			abattoir leased to M/s Al Saad Exports Pvt. Ltd. APEDA/191

Questioner for collection of Data from Slaughter Houses

Data sheet for Project on "Review of Effluent standards for Slaughter Houses" (Dept. of Environmental Tech., Central Leather Research Institute (CLRI), Chennai)		
Name of the Slaughter house		
Slaughter house Location	Address	
	District	
	State	
Contact details	Contact person	
	Address	
	Tel and fax	
	Mobile	
	Email	
Type of slaughter house	Manual / Semi automatic / Fully automatic	
Slaughter house owned by	Corporation / Municipality / Private agency	
Supervision and maintenance of slaughter house	Corporation / Municipality / Private agency	
Details of manpower in number	Permanent employees :	
	Temporary employees :	
Year of commissioning of slaughter house		
Present status	Operation / Not in operation	
Site Features	Total land area:	
	Total Building area:	
	Vacant area:	

Slaughter house operating details		Sheep & Goat	Buffalo & Ox	Others*
Designed capacity of slaughter house				
Number of animals slaughtered per day.	Minimum			
	Maximum			
Total number of animals slaughtered per month	Minimum			
	Maximum			
Live weight of the animal	Minimum			
	Maximum			
Charge/ fee collected per animal				
Working hours				
Holidays if any				
Whether segregation and recovery of useful products in slaughterhouse is practiced? If Yes, Please enclose details in separate sheet as Annexure.				
Quantity of water used per day	Minimum	_____ litres/day		
	Maximum	_____ litres/day		
Source from which water obtained	(Well / bore well / others _____)			
Power details	Total load : _____ KW Connected load : _____ KW			
Details of available facilities such as Weighing platform, conveyor system, flaying machine, laboratory etc.				

Details of recent upgradation and future expansion plan if any.	
Difficulties/ Problems faced in O&M of slaughterhouse and Waste management system, if any.	
Any other relevant information.	

Slaughter house waste generation details	Solid waste	Liquid waste
Maximum waste generated per day	_____ tones	_____ litres
Quantity of waste generated per month	_____ tones	_____ litres
Present method of waste disposal.		

Details of wastewater treatment system. (Enclose copy of ETP report and consent order issued by PCB)		
Treatment units	size	Treatment capacity

Operation and maintenance details of wastewater treatment system.	Own / Contractor
Operation and maintenance cost of waste management system	
Whether wastewater test reports are available. (If any may be enclosed)	Yes / No
Quantity of different types of solid wastes generated with its characteristics and present mode of disposal.	



237

Annexure-III

केन्द्रीय प्रदूषण नियंत्रण बोर्ड
CENTRAL POLLUTION CONTROL BOARD
पर्यावरण, वन एवं जलवायु परिवर्तन मंत्रालय भारत सरकार
MINISTRY OF ENVIRONMENT, FOREST & CLIMATE CHANGE GOVT. OF INDIA

SPEED POST

B-SH/IPC-IV/2021-22/12439-12484

13.01.2022
14

To

The Chairman
All SPCBs/PCCs (as per list enclosed)

SUB:Directions under section 18(1)(b) of the Water (prevention & control of pollution) Act, 1974 and the Air (prevention & control of pollution) Act, 1981 for installation of Rendering Plant by Slaughter House

WHEREAS, under Section 17 of the Water (Prevention & Control of Pollution) Act, 1974, and under Section 17 of the Air (Prevention & Control of Pollution) Act, 1981, one of the functions of the State Pollution Control Boards (SPCBs)/Pollution Control Committees (PCCs) is to plan a comprehensive programme for the prevention, control or abatement of pollution of streams, wells and air pollution in the State/Union territory and to secure the execution thereof; and

WHEREAS, under section 16 of the Water (Prevention and Control of Pollution) Act, 1974 and under Section 16 of the Air (Prevention & Control of Pollution) Act, 1981, one of the functions of the Central Pollution Control Board (CPCB), constituted under Water (Prevention and Control of Pollution) Act, 1974 is to coordinate activities of the SPCBs and PCCs and to provide technical assistance and guidance to SPCBs and PCCs; and

WHEREAS, the SPCBs and PCCs are empowered to stipulate standards for discharge of environmental pollutants for various categories of industries and common effluent treatment plants (CETPs), Common Hazardous waste and Biomedical waste incinerators more stringent than those notified by the Central Government under the Environmental (Protection) Act, 1986 and rules framed there under; and

WHEREAS, the SPCBs and PCCs also required to ensure installation and regular operation of the requisite pollution control facilities in the polluting industries so as to meet prescribed environmental norms; and

WHEREAS, Slaughter House is considered as polluting industrial process generating wastewater from different sources i.e. lairage area, floor cleaning, and hides storage area, which are highly polluted and should be adequately treated and discharged only after confirming to prescribed standards; and

1

'परिवेश भवन' पूर्वी अर्जुन नगर, दिल्ली-110032

Parivesh Bhawan, East Arjun Nagar, Delhi-110032

दूरभाष/Tel : 43102030, 22305792, वेबसाइट/Website : www.cpcb.nic.in

WHEREAS, substantial quantity of solid waste is generated from Slaughter Houses in the form of animal carcasses, waste meat and inedible body parts of animal such as cartilage, bones, fat, blood, etc. This solid waste is generally disposed at isolated places which causes odour and public nuisance; and

WHEREAS, blood produced during slaughtering of animal is collected and processed in blood coagulator to convert into Meat Blood Meal (MBM); and

WHEREAS, CPCB carried out inventory of slaughter houses operating in the country. The analysis of inventory data revealed the following:

- a. Most of the Slaughter Houses in the country are operating without Rendering Plant. This condition is more prevalent in Slaughter Houses managed by the Municipalities.
- b. Most of the Slaughter Houses dumped their solid waste at isolated places i.e. Municipal dumping sites /Sanitary Landfill Sites (SLF), which causes odour, create public nuisance and unhygienic conditions.
- c. Most of the Slaughter Houses under the control of Municipal bodies are operating without consent and do not have wastewater treatment and solid waste management facilities.

Now, therefore, in exercise of the powers conferred under Section 18 (1) (b) of the Water (Prevention & Control of Pollution) Act, 1974, and Air (Prevention & Control of Pollution) Act, 1981, all SPCBs/PCCs are directed to issue following direction to the Slaughter Houses in their States/UTs:

1. To Install Rendering Plant (dry) along with blood coagulator for processing of animal waste.
2. To install well designed effluent Treatment Plant for treatment of wastewater so that the treated effluent comply with the standards prescribed under Environment (P) Act, 1986.
3. To discontinue operation of slaughter house without Consent under Water Act 1974 and Air Act, 1981.

The State Pollution Control Boards/Pollution Control Committees shall acknowledge the receipt of these directions within a week and submit detailed Action Taken Reports within two weeks thereafter.

Mⁿ 14/1/22
(Tanmay Kumar)
Chairman

Copy to:

1. Joint Secretary (CP Division), Ministry of Environment, Forest & Climate Change, Indira Paryavaran Bhawan, Jor Bagh, New Delhi-110003 : For information please
2. Regional Directors (as per list enclosed) : For necessary follow up please
3. Divisional Head, IT Division, Delhi : For uploading on CPCB website please

(Prashant Gargava)
Member Secretary

List of all State Pollution Control Board & Pollution Control Committee

<p>1. The Chairman Andhra Pradesh Pollution Control Board D. No. 33-26-14 D/2, Near Sunrise Hospital, Pushpa Hotel Centre, Chalamalavari Street, Kasturibaipet, Vijayawada - 520010</p>	<p>2. The Chairman Arunachal Pradesh State Pollution Control Board Govt. of Arunachal Pradesh, Department of Environment & Forest, Paryavaran Bhawan, Yupia Road, Papunalah, Naharlagun - 791110</p>
<p>3. The Chairman Pollution Control Board- Assam, Bamunimaidam, Guwahati - 781021 (Assam)</p>	<p>4. The Chairman Bihar State Pollution Control Board Parivesh Bhawan, Plot No. NS-B/2, Paliputra Industrial Area, Patliputra, Patna - 800023 (Bihar)</p>
<p>5. The Chairman Chhattisgarh State Environment Conservation Board, Paryavas Bhawan, North Block Sector-19, Naya Raipur - 492002 (Chhattisgarh)</p>	<p>6. The Chairman Goa State Pollution Control Board Nr. Pilerne Industrial Estate, Opposite Saligao Seminary, Saligao Bardez- 403511 (Goa)</p>
<p>7. The Chairman Gujarat Pollution Control Board Paryavaran Bhavan, Sector 10-A, Gandhi Nagar 382010 (Gujarat)</p>	<p>8. The Chairman Haryana State Pollution Control Board C-11, Sector-6, Panchkula- 134109 (Haryana)</p>
<p>9. The Chairman Himachal Pradesh State Pollution Control Board Him Parivesh, Phase-III, New Shimla - 171009</p>	<p>10. The Chairman J&K State Pollution Control Committee, Parivesh Bhawan, Shiekh-ul-Campus, behind Govt. Silk Factory, Raj Bagh, Srinagar - 190008 (J&K)</p>
<p>11. The Chairman Jharkhand State Pollution Control Board T.A. Bldg., HEC, P. O. Dhurwa, Ranchi-834004 (Jharkhand)</p>	<p>12. The Chairman Karnataka State Pollution Control Board "Parisara Bhavan", #49,4th & 5th Floor, Church Street, Bangalore 560 001</p>
<p>13. The Chairman Kerala State Pollution Control Board Head Office, Pattom. P. O Thiruvananthapuram- 695 004 (Kerala)</p>	<p>14. The Chairman Madhya Pradesh Pollution Control Board Paryavaran Parisar, E-5, Arera Colony, Bhopal - 462016 (Madhya Pradesh)</p>

<p>15. The Chairman Maharashtra Pollution Control Board, Kalpataru Points, 3rd & 4th Floor, Sion Matunga Scheme Road No.6 Opp. Cine Planet, Sion Circle, Sion (E), Mumbai-400022</p>	<p>16. The Chairman Manipur Pollution Control Board Lamphalpat, Imphal – 795004 (Manipur)</p>
<p>17. The Chairman Meghalaya State Pollution Control Board, "ARDEN", Lumpyngad, Shillong– 793014 (Meghalaya)</p>	<p>18. The Chairman Mizoram Pollution Control Board New Secretariat Complex, Khatla, Aizawl – 796001 (Mizoram)</p>
<p>19. The Chairman Nagaland Pollution Control Board Signal Point, Dimapur - 797112 (Nagaland)</p>	<p>20. The Chairman Odisha State Pollution Control Board Paribesh Bhawan, A-118, Nilakantha Nagar, Unit VIII Bhubaneswar-751012 (Odisha)</p>
<p>21. The Chairman Punjab Pollution Control Board Vatavaran Bhawan, Nabha Road Patiala 147 001 (Punjab)</p>	<p>22. The Chairman Rajasthan Pollution Control Board, A-4, Institutional Area, Jalana Dungri, Jaipur 302 004 (Rajasthan)</p>
<p>23. The Chairman Sikkim State Pollution Control Board State Land Use & Environment Cell Govt. of Sikkim, Deorali Gangtok – 737102 (Sikkim)</p>	<p>24. The Chairman Tamil Nadu Pollution Control Board 76, Anna Salai, Guindy Industrial Estate, Race View Colony, Guindy, Chennai-600032 (Tamil Nadu)</p>
<p>25. The Chairman Telangana State Pollution Control Board Paryavarana Bhavan, A-III, Industrial Estate, Sanathnagar, Hyderabad-500018 (Telangana)</p>	<p>26. The Chairman Tripura State Pollution Control Board Parivesh Bhawan, Pandit Nehru Complex P.O. Kunjaban, Gorkhabasti, Agartala – 799 006 (Tripura)</p>
<p>27. The Chairman Uttar Pradesh Pollution Control Board IIIrd Floor PICUP Bhavan Vibhuthi Khand, Gomti Nagar, Lucknow – 226 020, (Uttar Pradesh)</p>	<p>28. The Chairman Uttarakhand Environment Protection & Pollution Control Board 29/20, Nemi Road, Dalanwala, Dehradun – 248 001 (Uttarakhand)</p>

<p>29. The Chairman West Bengal Pollution Control Board Paribesh Bhavan, 10-A, Block LA, Sector III, Salt Lake City, Kolkata-700 091 (West Bengal)</p>	<p>30. The Chairman Andaman & Nicobar Islands Pollution Control Committee, Department of Science & Technology, Dollyganj Van Sadan, Haddo P.O Port Blair-744102 (Andaman & Nicobar)</p>
<p>31. The Chairman Chandigarh Pollution Control Committee Paryavaran Bhawan, Ground Floor, Sector-19 B, Madhya Marg, Chandigarh - 160 019</p>	<p>32. The Chairman Pollution Control Committee, UTs of Daman, Diu and Dadra & Nagar Haveli Fort Area, Court Compound, Moti Daman - 396 220</p>
<p>33. The Chairman Delhi Pollution Control Committee, Government of N.C.T. Delhi 4th Floor, ISBT Building, Kashmere Gate, Delhi-110 006</p>	<p>34. The Chairman Lakshadweep Pollution Control Committee Department of Science, Technology & Environment, Kavarati-682555</p>
<p>35. The Chairman Puducherry Pollution Control Committee 'B' Block, Ground Floor, Chief Secretariat, Puducherry-605 001</p>	<p>36. The Chairman Ladakh Pollution Control Committee Wildlife Office Building, Near Council Secretariat, Opposite Police Station Housing Colony, Leh-194101 (Ladakh)</p>

List of all Regional Directorates

<p>1. Regional Director (Bengaluru) Central Pollution Control Board A-Block, Nisarga Bhavan 1st and 2nd Floors, 7th D Cross Thimmaiah Road, Shivanagar Bengaluru-560079</p>	<p>2. Regional Director (Bhopal) Central Pollution Control Board Parivesh Bhawan, Paryavaran Parisar E-5, Arera Colony Bhopal - 462016</p>
<p>3. Regional Director (Kolkata) Central Pollution Control Board 'South end Conclave' Block-502 5th & 6th Floor, 1582, Razidanga, Main Road Kolkata-700107</p>	<p>4. Regional Director (Lucknow) Central Pollution Control Board PICUP Bhawan, Vibhuti Khand, Gomti Nagar Lucknow-226020</p>
<p>5. Regional Director (Shillong) Central Pollution Control Board "TUM-SIR", Lower Moti nagar, Near Fire Brigade H.Q., Shillong-793014</p>	<p>6. Regional Director (Vadodara) Central Pollution Control Board Parivesh Bhawan, Opp. Ward No. 10 VMC Office Subhanpura, Vadodara - 390023</p>
<p>7. Regional Director (Chennai) Central Pollution Control Board 77-A, 2nd Floors, South Avenue Road Ambattur Industrial Esate Ambattur Taluk, Thiruvallur District Chennai-600058</p>	<p>8. Regional Director (Chandigarh) Central Pollution Control Board Second Floor, BSNL Telephone Exchange, Sector-49, Chandigarh - 160047</p>
<p>9. Regional Director (Pune) Central Pollution Control Board Row House No. 1, Nisarg Vihar, Balewadi Pune-411045</p>	